



control solutions
TERACOM



TCG140-4 LTE universal IO module

USER MANUAL

1. Short description

TCG140-4 is a 4G LTE Cat.1 universal I/O module. It supports also 3G and 2G wireless communication and provides data connectivity on LTE-FDD, DC-HSDPA, HSPA+, HSDPA, HSUPA, WCDMA, EDGE, and GPRS networks.

The device has 2 digital inputs, 4 analog inputs, digital interfaces for external sensors, and 4 relays. Two of the analog inputs can be switched either in a current loop (0-20mA) or voltage modes. The relays can be activated either remotely (via SMS or HTTP API command) or locally - from the status of the monitored parameters.

TCG140-4 supports all digital sensors of Teracom.

All monitored parameters and the status of relays can be periodically saved in the embedded data logger. It is also possible to arrange records on any alarm condition.

The universal I/O module supports HTTP API for easy M2M communication. The device sends periodically an HTTP/HTTPS Post to a remote server with an XML/JSON status file. As an answer, the server can send commands for relay activation or settings change.

2. Features

- Multi-band connectivity;
- Data logger with up to 70000 records;
- Setup via USB, SMS, and HTTP API;
- 2 digital "dry contact" inputs;
- Up to 4 analog inputs with 0 to 10VDC range;
- Up to 2 current loop (4-20mA) inputs;
- Settable multiplier, offset, and dimension for analog inputs;
- 4 relays with NO and NC contacts;
- 1-Wire support for all Teracom sensors;
- MODBUS RTU sensors support;
- MQTT 3.1.1 support;
- SMS alarm alerts for up to 5 numbers;
- Email alarm alerts for up to 5 email recipients;
- Periodical HTTP/HTTPS Post with current status in XML or JSON file to a remote server;
- Periodical HTTP/HTTPS Post with logger data in CSV format to a remote server;
- HTTP API commands;
- Firmware update over USB or Internet.

3. Applications

TCG140-4 is suitable for industrial automation, data acquisition systems, environmental monitoring, local control of an electrical and non-electrical parameter, building automation, etc.:

- SCADA systems
TCG140-4 be easily integrated into SCADA systems. The periodical HTTP/HTTPS Post is suitable for client-server platforms.
- Stand-alone data logger
The device can be used as a standard data logger with a minimum record time as low as 1 minute. The logged data can be periodically uploaded to a dedicated server as a CSV file.
- Environmental monitoring and control

4. Specifications

- Physical characteristics
 - Dimensions: 158 x 119 x 34 mm
 - Weight: 470 g
 - Mounting: wall and DIN rail
- Environmental limits
 - Operating temperature: -20 to 55°C
 - Operating temperature for USB setup: 0 to 40°C
 - Storage temperature: -25 to 60°C
 - Ambient Relative Humidity: 5 to 85% (non-condensing)
- Standards and Certifications
 - Safety: EN 62368-1:2014 + EN 62368-1:2014/AC1-3:2015 + EN 62368-1:2014/A11:2017 + EN 62368-1:2014/AC:2017-03:2017, EN 62311:2008
 - EMC: EN 55032: 2015 + EN 55032: 2015/AC:2016-07 + EN 55032: 2015/A11:2020
EN 55024: 2010 + EN 55024: 2010/A1:2015
EN 61000-3-2: 2014
EN 61000-3-3: 2013 + EN 61000-3-3: 2013/A1:2019
 - RFU: EN 301 489-19 V2.1.1, EN 301511 V12.5.1, EN 301 908-1 V11.1.1, EN 301 908-13 V11.1.2, EN 301 908-2 V11.1.2, EN 303 413 V1.1.1
 - Green: RoHS
- Warranty
 - Warranty period: 3 years
- Power supply
 - Operating voltage range (including -15/+20% according to IEC 62368-1): 10 to 28 VDC
 - Current consumption: 0.37A @ 12VDC
- Cellular interface
 - Standards: LTE-FDD, DC-HSDPA, HSPA+, HSDPA, HSUPA, WCDMA, EDGE and GPRS
 - Bands (TCG140-4e variant):
 - 4G LTE: B1/B3/B7/B8/B20/B28
 - 3G: B1/B8
 - 2G: B3/B8
 - Bands (TCG140-4n variant):
 - 4G LTE: B2/B4/B5/B12/B13/B25/B26
 - 3G: B2/B4/B5
 - 2G: Not supported
 - Bands (TCG140-4a variant):
 - 4G LTE: B1/B2/B3/B4/B5/B7/B8/B28/B66
 - 3G: B1/B2/B5/B8
 - 2G: B2/B3/B5/B8
 - SIM card size: Micro
 - Antenna connector: SMA-F
- Analog inputs
 - Isolation: Non-isolated
 - Type: Single-ended
 - Resolution: 10 bits
 - Mode (Analog inputs 1 and 2): Voltage
 - Mode (Analog inputs 3 and 4): Voltage / Current (WEB interface selectable)
 - Input Range: 0 to 10 VDC, 0 to 20 mA

Accuracy: $\pm 1\%$

Sampling Rate: 500ms per channel (averaged value of 250 samples)

Input Impedance: 1 mega-ohm (min.)

Built-in resistor for current mode: 410 ohms

- Digital inputs

Isolation: Non-isolated

Type: Dry contact

Sampling rate: 10ms

Digital filtering time period: 30ms

- Relay outputs

Type: Form C (N.O. and N.C. contacts)

Contact current rating: 3 A @ 24 VDC, 30 VAC (resistive load)

Initial insulation resistance: 100 mega-ohms (min.) @ 500 VDC

Mechanical endurance: 10 000 000 operations

Electrical endurance: 100 000 operations @ 3 A resistive load

Contact resistance: 50 milli-ohms max. (initial value)

Minimum pulse output: 0.1 Hz at rated load

CAUTION: The device does not contain any internal overcurrent protection facilities on the relays' contact lines.

External fuses or short circuit current limiting circuit breakers, rated to 3 Amps, are to be used for overcurrent protection of the connecting lines.

- Digital sensor interfaces (1-Wire and RS-485)

Output voltage: 5.0 ± 0.3 VDC

Maximum output current (for both interfaces): 0.2A

- Internal FLASH memory

Endurance: 100 000 cycles (any save command or full scroll (70000 records) of the logger)

- Lithium battery

Type: CR1220

 **Caution!** Risk of explosion if the battery is replaced by an incorrect type.

5. Installation

This device must be installed by qualified personnel. The installation consists of mounting the device, connecting the antenna, connecting inputs and outputs, providing power, and configuring via a web browser. This device must not be installed directly outdoors.

Attention! Before installing the SIM card in the card slot, please ensure that the PIN code is disabled.

5.1. Mounting

TCG140-4 should be mounted in a clean and dry location on a non-flammable surface. Ventilation is recommended for installations where the ambient air temperature is expected to be high.

Mount the device to a wall by using two plastic dowels 8x60mm (example Würth GmbH 0912 802 002) and two dowel screws 6x70mm (example Würth GmbH 0157 06 70). See Appendix C, fig. 1 for mechanical details.

Maintain spacing from adjacent equipment. Allow 50 mm of space on all sides, as shown in fig.2 in Appendix C, this provides ventilation and electrical isolation.

For DIN rail mounting, a DIN-RAIL-MOUNT-KIT should be used.

5.2. Connectors

Attention! Disconnect the power supply before wiring.

The correct wiring procedure is as follows:

- Make sure power is turned off;
- Make wiring connections to the terminals;
- Apply power.

It is recommended to test and configure TCG140-4 without any controlled device.

Make sure that wires are properly attached to the terminals and that the terminals are tightened. Not proper wiring and configuration can cause permanent damage to the module or the equipment to which it is connected or both.

Inputs and outputs locations are shown below:

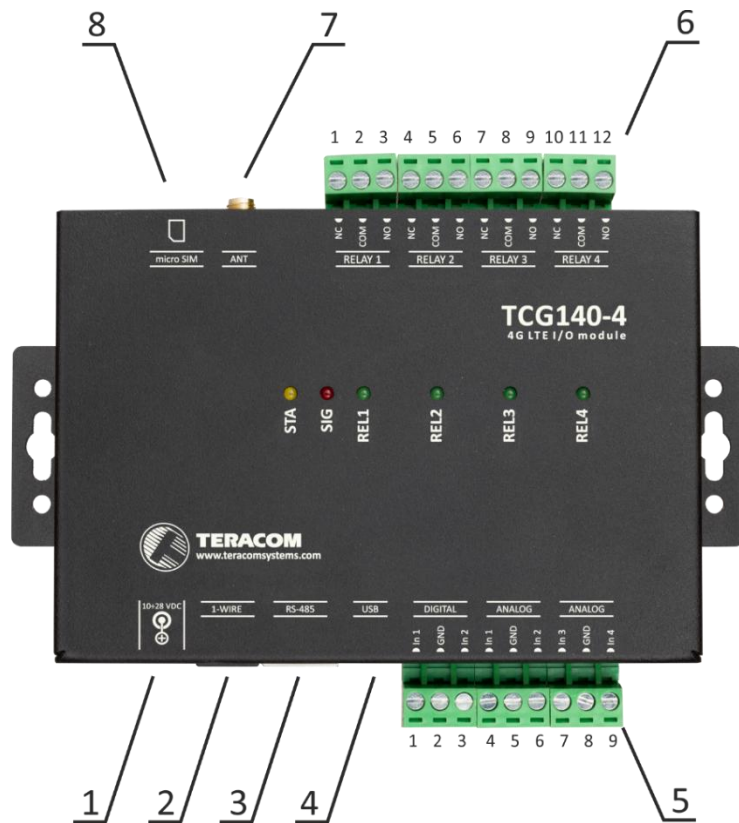

| | | | |
|--------------------|-----------------------------------|--------------------|---------------------|
| Connector 1 | Power - 2.1x5.5, central positive | Connector 6 | Pin1 – NC Relay 1 |
| Connector 2 | 1-Wire interface | | Pin2 – COM Relay 1 |
| Connector 3 | RS-485 interface | | Pin3 – NO Relay 1 |
| Connector 4 | mini USB | | Pin4 – NC Relay 2 |
| Connector 5 | Pin1 – Digital In 1 | | Pin5 – COM Relay 2 |
| | Pin2 – Ground | | Pin6 – NO Relay 2 |
| | Pin3 – Digital In 2 | | Pin7 – NC Relay 3 |
| | Pin4 – Analog In 1 | | Pin8 – COM Relay 3 |
| | Pin5 – Ground | | Pin9 – NO Relay 3 |
| | Pin6 – Analog In 2 | | Pin10 – NC Relay 4 |
| | Pin7 – Analog In 3 | | Pin11 – COM Relay 4 |
| | Pin8 – Ground | | Pin12 – NO Relay 4 |
| | Pin9 – Analog In 4 | Connector 7 | GSM Antenna |
| | | Connector 8 | SIM card |

Connector 2



| Pin | Description | Corresponding UTP wires color |
|-----|------------------------|-------------------------------|
| 1 | 1-Wire GND (most left) | White/Brown |
| 2 | 1-Wire GND | White/Green |
| 3 | 1-Wire Data | Green |
| 4 | 1-Wire GND | White/Orange |
| 5 | 1-Wire +VDD | Orange |
| 6 | 1-Wire +VDD | Brown |

Connector 3

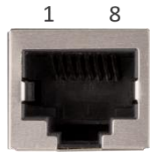

| Pin | Description | Corresponding UTP wires color |
|-----|---------------------------|-------------------------------|
| 1 | not connected (most left) | Orange/White Tracer |
| 2 | not connected | Orange |
| 3 | not connected | Green/White Tracer |
| 4 | Line B- | Blue |
| 5 | Line A+ | Blue/White Tracer |
| 6 | not connected | Green |
| 7 | +VDD | Brown/White Tracer |
| 8 | GND | Brown |

5.2.1. Power supply connection

TCG140-4 is designed to be supplied by adapter SYS1308-2412-W2E or similar, intended for use in the conditions of overvoltage category II. The power supply equipment shall be resistant to short circuits and overload in a secondary circuit.

When in use, do not position the equipment so that it is difficult to disconnect the device from the power supply.

5.2.2. 1-Wire interface

1-Wire is a registered trademark of Maxim integrated products, Inc. It is designed to connect several sensors over short wiring. It is not suitable for long distances or noisy environments.

The maximum number of sensors (1-Wire or RS-485) connected to TCG140-4 is eight.

The device supports all Teracom 1-Wire sensors. Connected sensors are automatically detected and the appropriate dimension is assigned.

It is strongly recommended to use “daisy-chained” (linear topology) for multi-sensor systems:



It is strongly recommended to use only UTP/FTP cables and keep the total cable length up to 30m. Although functionality has been achieved in the longer distance, we cannot guarantee error-free operation over mentioned wiring length. We recommend reading Maxim's 1-Wire tips at <https://www.maximintegrated.com/en/design/technical-documents/tutorials/1/148.html>.

We guarantee proper operation only with Teracom 1-Wire sensors.

5.2.3. RS-485 interface

RS-485 is a standard for serial communications systems defined by Telecommunications Industry Association (TIA) and Electronic Industries Alliance (EIA). Implementing the standard, communication systems can be used effectively over long distances and in electrically noisy (industrial) environments.

The maximum number of sensors (1-Wire or RS-485) connected to TCG140-4 is eight.

MODBUS RTU protocol specifies that the address of the device should be between 1 and 247. The user should take care of appropriate address settings.

For multi-sensor systems “daisy-chained” (linear topology) should be used:

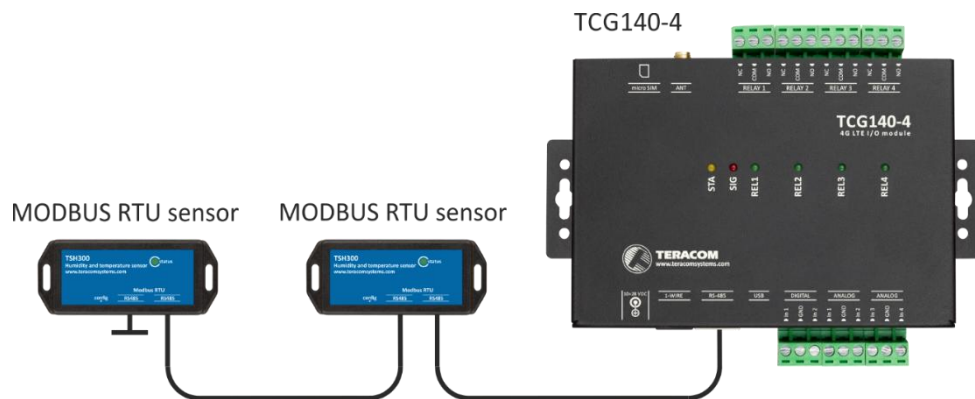

Interconnections are realized by UTP/FTP cables with RJ-45 connectors. The popular Ethernet wiring standard ANSI/TIA/EIA T568B is used.

It is recommended to use standard patch cables for LAN networks.

Attention! Special care should be paid on termination of the bus. The last sensor in the chain should have a 120-ohm terminator installed on the free RJ-45 socket. The terminator is delivered with the module.

We recommend keeping the total cable length up to 30 m, although the RS-485 interface works over a much longer distance.

5.2.4. Digital inputs connection

Attention! Digital inputs are NOT galvanic isolated.

The TCG140-4 digital inputs can be used as “dry contact” only.

The term “dry contact” means that to this input can be connected devices with an open drain or relay outputs - door contact switch, push-button, PIR detector, etc.

The following picture illustrates how an alarm button can be connected to a digital input of TCG140-4. One side of the contact is connected to “Digital In” while the other side is connected to the “GND” terminal.



The maximum cable length for a digital input should be up to 30 meters.

5.2.5. Analog inputs connection

Attention! Analog inputs are NOT galvanic isolated.

Analog inputs of TCG140-4 can be used for monitoring DC voltage up to 10VDC. They can be connected directly to sensors and transmitters with such analog output.

The “Multiplier”, “Offset” and “Dimension” for every analog input gives a possibility to monitor sensors with analog outputs and see directly the measured parameter.

It is possible to monitor voltages bigger than 10VDC by adding an external resistor in series. For every 1 mega-ohm, the voltage will be extended by 5.893V. The external resistor should be with 1% or better accuracy.

To analog inputs 3 and 4 internally can be assigned 410-ohm resistor in parallel of the input. In this case, the input can accept directly 0-20mA current loop sensors and transmitters.

The switching of the resistor is done by the user interface.

The following picture illustrates how a 0-10V analog sensor is connected to the analog input 1 and 0-20mA current loop transmitter is connected to analog input 3. The analog input 3 is in current mode.

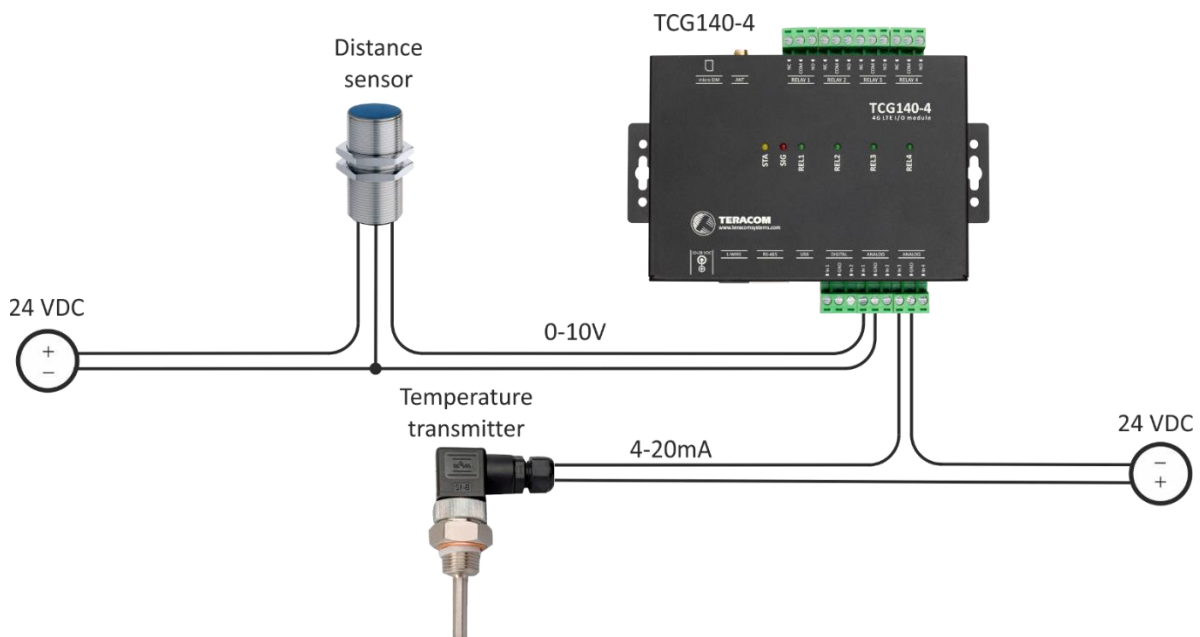

The maximum cable length for an analog input should be up to 30 meters.

5.2.6. Relays connection

The relay contacts are internally connected directly to the terminal connectors.

Attention! There isn't any internal overcurrent protection on the relays' contact lines.

For all relays normally open, normally closed and common contacts are available. For loads with higher switchable current/voltage than specified, an external relay should be used.

When mechanical relays switch inductive loads such as motors, transformers, relays, etc., the current will arc across the relay contacts each time the contacts open. Over time, this cause wears on the relay contacts which shorten their life. When switching an inductive load, it is recommended that relay contact protection devices are used.

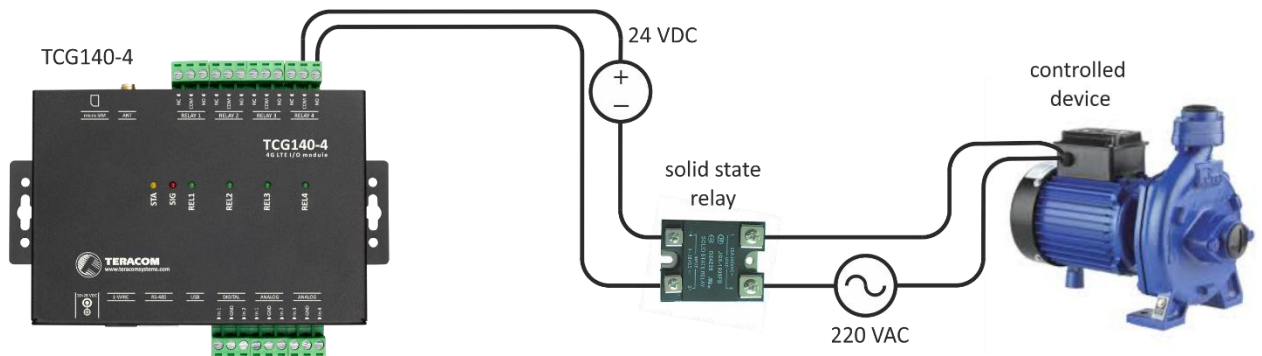

6. LED indicators

LED indicators show the status of the module:

- **REL1 - REL4** (green) – the LED is ON when the corresponding relay is activated (the NO contact is connected to COM);
- **SIG** (red) – indicates the status of the device together with STA
- **STA** (yellow) – indicates the status of the device together with SIG.

The following states are displayed:

- **Module initialization** – after power-on SIG and STA turn ON for a second, after this turn OFF for another second.

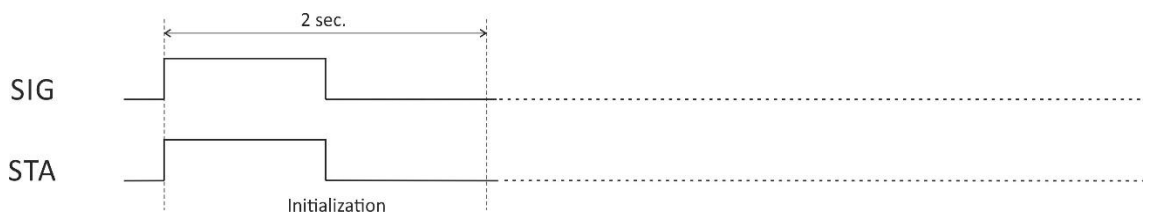

- **Searching for a network** – after initialization, SIG is OFF, STA flashes (flash period of 200ms)

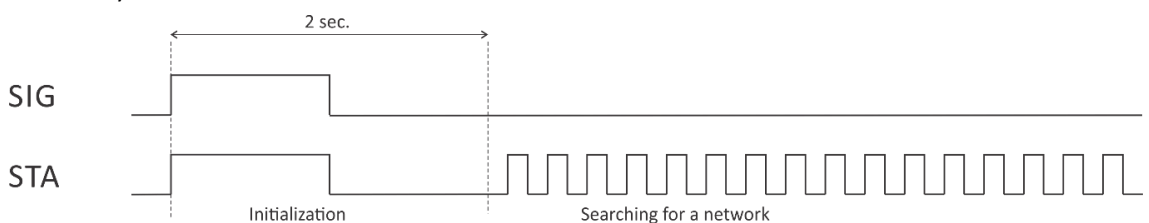

- **Connected to a network** – after a successful connection to a mobile network, STA shows the type of connection, while SIG shows the signal strength.

STA flashes ones for 200ms in a period of 2s – there is GSM connection only;

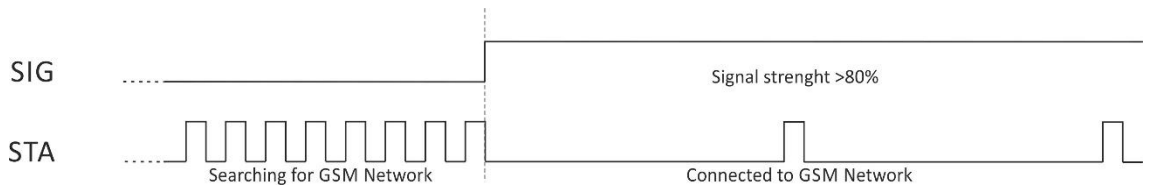

STA flashes twice for 200mS in a period of 2s – there are GSM and 4G/3G/2G connections.

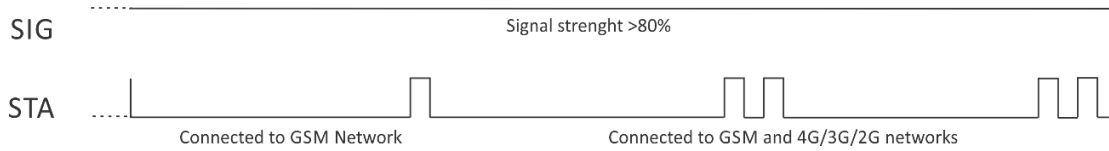

At the same time SIG has 5 states:

- SIG flashes 1 time in a period of 2s – signal strength is between 0 and 20%;
- SIG flashes 2 times in a period of 2s – signal strength is between 21 and 40%;
- SIG flashes 3 times in a period of 2s – signal strength is between 41 and 60 %;
- SIG flashes 4 times in a period of 2s – signal strength is between 61 and 80%;
- SIG is solid ON – signal strength is between 81 and 100%;

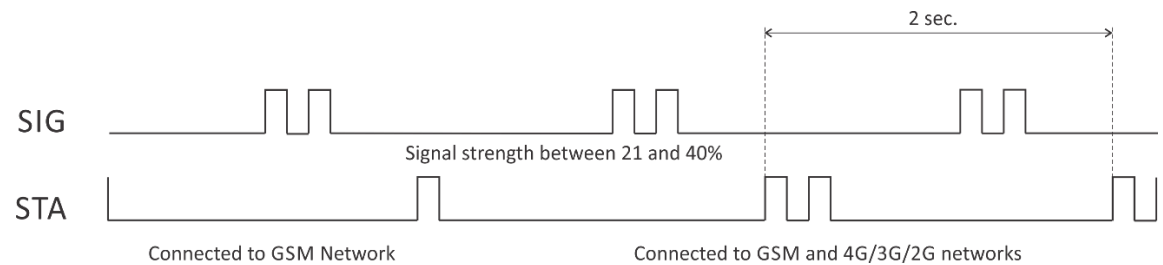
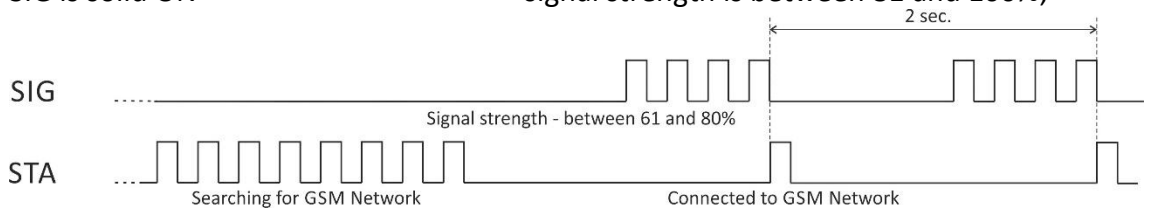

- **Error message** – in case of error after initialization, SIG will stay solid OFF, STA will flash showing the type of error.

- STA flashes ones for 1s – master phone number is not set;
- STA flashes permanently for 1s in a period of 2s – permanent hardware error.

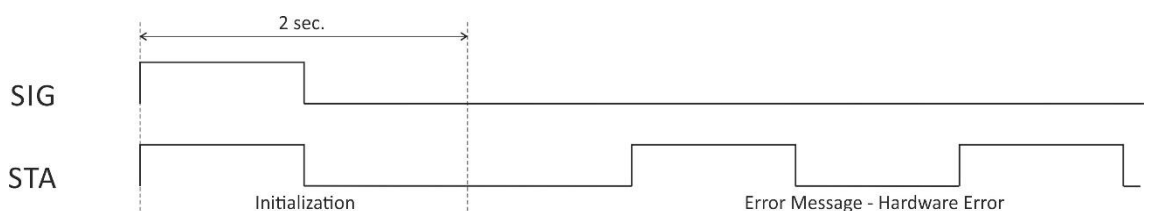
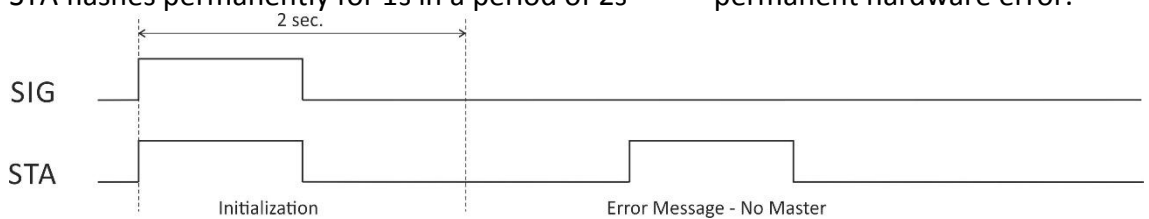

7. Initial setup via USB

The initial setup of TCG140-4 is done with a computer running Windows 7 or a newer Microsoft Windows operating system. After power-up, the module should be connected to the computer with a USB cable. Once the USB cable is connected, the operating system automatically starts to install the drivers for the communication with the device. The following message appears:

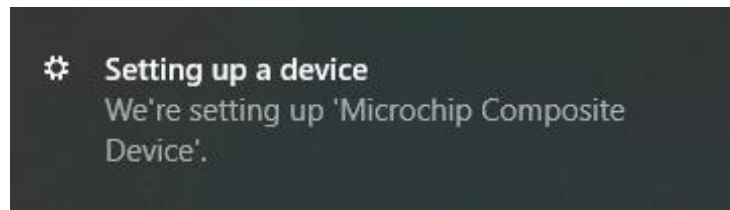

The following drivers will be installed:

- Microchip composite device
- USB serial port driver

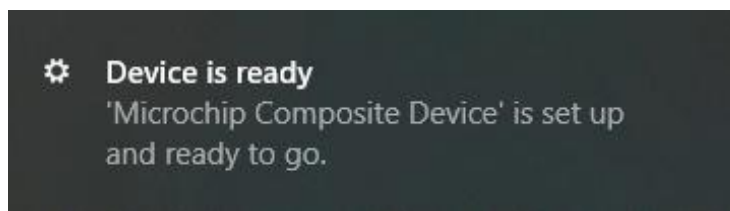

If for some reason the USB serial port driver cannot be installed automatically, it must be installed manually.

The driver can be downloaded from the TCG140-4 product page at www.teracomsystems.com. After successful driver installation, the device will be recognized as Mass storage, the following window appears on the screen:

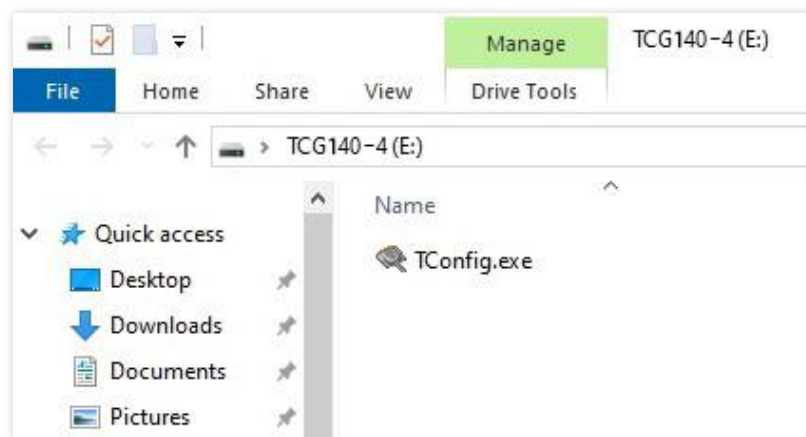

The only file stored on the mass storage is a tool called "TConfig". This tool enables communication between the TCG140-4 and PC. After starting the TConfig tool, the following program will appear:

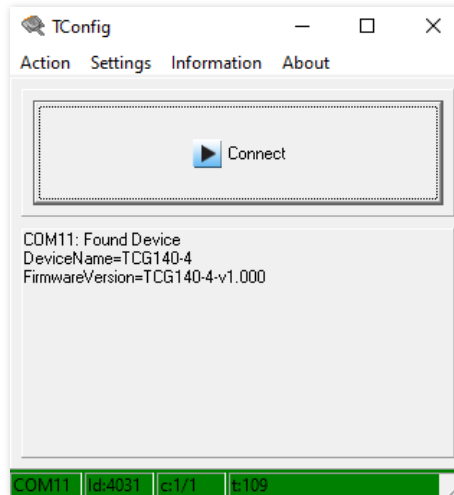

Pressing the “Start” button will start the browser and display the Monitoring page of your TCG140-4.

7.1. Monitoring page

The monitoring page displays the current inputs/outputs status of TCG140-4. The page has 5 sections – “1-Wire sensors”, “Modbus sensors”, “Digital inputs”, “Analog inputs” and “Relays”.

For every parameter (sensor, input, relay) there is a description of up to 15 characters. The descriptions can be changed on the “Setup-Input/Output” page.

7.1.1. Sensors section

| 1-Wire sensors | | | | |
|----------------|-------------|---------|---------|------------------|
| Pos | Description | Value 1 | Value 2 | ID |
| 1 | S1:TSH2xx | 30.3°C | 54.3%RH | 015225B71700FF45 |
| 2 | S2 | | | 0000000000000000 |
| 3 | S3 | | | 0000000000000000 |
| 4 | S4 | | | 0000000000000000 |

| Modbus sensors | | | | |
|----------------|-------------|---------|---------|---------|
| Pos | Description | Value 1 | Value 2 | Address |
| 5 | S5 | 28.9°C | | 1 |
| 6 | S6 | 28.7°C | 54.3%RH | 2 |
| 7 | S7 | | | 0 |
| 8 | S8 | | | 0 |

There are two sensors sub-sections on the page - one for 1-Wire sensors and another one for MODBUS RTU sensors.

TCG140-4 supports up to eight sensors. They can be connected to both interfaces in a random ratio, settable in section “Sensors ratio setup” on the Setup->Sensors page. By default, the number of MODBUS RTU sensors is 4.

All detected 1-Wire sensors are shown in the “1-Wire sensors” sub-section. The sensors should be set up in section “1-Wire sensors setup” on the Setup->Sensors page.

All MODBUS RTU sensors are shown in the “Modbus sensors” sub-section. The sensors should be added and set up in section “Modbus RTU sensors” on the Setup->Sensors page.

For every sensor, there is a description, value, ID, or address information. The description length is up to 15 characters. The descriptions can be changed on the Setup->Conditions page.

Dual sensors (humidity-temperature) have two parameters.

7.1.2. Digital inputs section

Digital inputs

| Digital input | Status | Digital input | Status |
|-----------------|--------|-----------------|--------|
| Digital Input 1 | OPEN | Digital Input 2 | OPEN |

Digital inputs can be used for monitoring the state of discrete devices – motion sensor, door contact, relay contact, alarm output, etc.

Digital inputs are sampled every 10ms. The change of input status is considered valid if the same value is read in 3 consecutive samples (30ms).

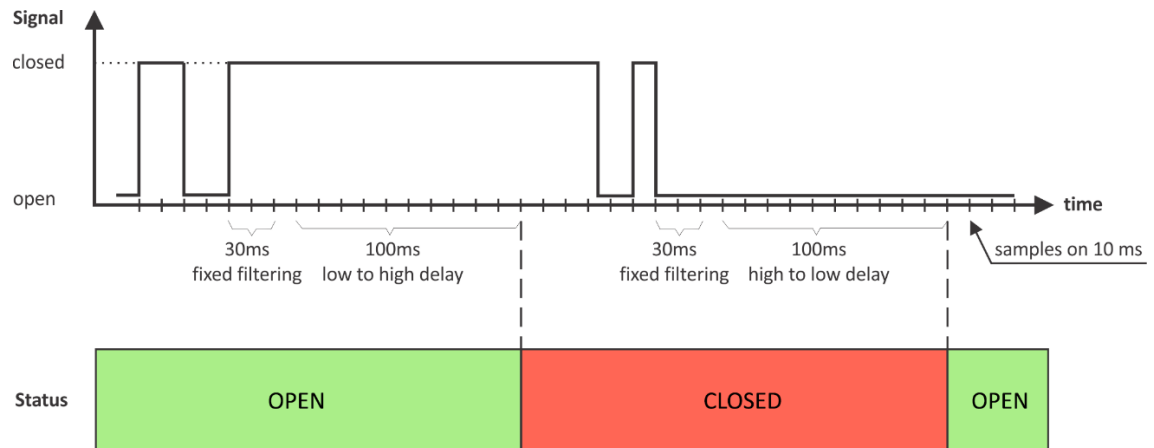

The status of every input is shown by text and by color.

The descriptions and status texts can be changed in “Setup-Input/Output”.

7.1.3. Analog inputs section

Analog inputs

| Analog input | Value | Analog input | Value |
|----------------|--------|----------------|--------|
| Analog Input 1 | 0.000V | Analog Input 2 | 0.000V |
| Analog Input 3 | 0.000V | Analog Input 4 | 0.000V |

Analog inputs can be used for monitoring DC voltage sources – analog sensors, batteries, power supplies, solar panels, etc.

Analog inputs 3 and 4 can be also used for monitoring of 0-20mA current loop sensors/transmitters. The mode can be changed on the “Setup-> Input/Output” section.

Analog inputs are sampled faster, but the new actual value is changed in 0.5 seconds. All 250 readings between the value changes are averaged.

For every analog input “Unit”, “Multiplier” and “Offset” can be set in the “Setup-> Input/Output” section.

7.1.4. Relay section

| Relay | Status | Control |
|---------|--------|-----------------------------------------------------------------------------------------------------------------------|
| Relay 1 | OFF | <input type="button" value="ON"/> <input type="button" value="OFF"/> <input type="button" value="Pulse"/> |
| Relay 2 | OFF | <input type="button" value="ON"/> <input type="button" value="OFF"/> <input type="button" value="Pulse"/> |
| Relay 3 | OFF | <input type="button" value="ON"/> <input type="button" value="OFF"/> <input type="button" value="Pulse"/> |
| Relay 4 | OFF | <input type="button" value="ON"/> <input type="button" value="OFF"/> <input type="button" value="Pulse"/> |
| | | <input type="button" value="All On"/> <input type="button" value="All Off"/> <input type="button" value="Pulse All"/> |

The section displays the current state of relays. Each relay can be activated either remotely or locally from the status of a monitored parameter. For locally activated relays a text describing the controlling parameter is displayed rather than buttons.

Pulse duration and parameters for local relay activation can be set separately for each relay in “Setup->Input/Output->Relay outputs”.

7.2. Setup

7.2.1. SMS

The screenshot shows two main sections: "SMS Setup" and "Alarm Notification".

SMS Setup:

- Master: +359882569989
- User 1: [Empty field]
- User 2: [Empty field]
- User 3: [Empty field]
- User 4: [Empty field]
- send test SMS: [Button]

Alarm Notification:

- Phone number format: [+][Country code][Network prefix][Number]
- User 1:
- User 2:
- User 3:
- User 4:

SMS alarm recipients can be set in this section.

The “Master” has special rights to change the device settings using SMS commands. This number always receives SMS alarm messages.

The remaining 4 recipients can receive SMS messages if any of the parameters are in an alarm state. To receive the SMS messages for every number should be enabled with the checkbox “Alarm Notification”. These 4 recipients can also ask by SMS for parameter state/value.

By pressing the “Send test SMS” button all SMS recipients will receive a test SMS.

All commands, their syntax, and answers are described in “Setup via SMS”.

SMS is not a reliable communication and it is not recommended as a monitoring technology.

7.2.2. Sensors

7.2.2.1. Sensors ratio setup

The screenshot shows the "Sensors ratio setup" interface with the following fields:

- Number of 1Wire sensors: 4
- Number of Modbus sensors: 4
- Save: [Button]

The ratio between 1-Wire and MODBUS RTU sensors can be set here. By default, it is 4:4.

7.2.2.2. 1-Wire sensors setup

The screenshot shows the "1-Wire sensors setup" interface with a table of sensors and a "Scan" button.

| Pos | Description | Value 1 | Value 2 | ID | Lock |
|-----|-------------|---------|---------|------------------|--------------------------|
| 1 | S1:TST1xx | 23.9°C | ----- | 2867895F07000058 | <input type="checkbox"/> |
| 2 | S2 | ----- | ----- | 0000000000000000 | <input type="checkbox"/> |
| 3 | S3 | ----- | ----- | 0000000000000000 | <input type="checkbox"/> |
| 4 | S4 | ----- | ----- | 0000000000000000 | <input type="checkbox"/> |

Scan: [Button]

Detection of connected 1-Wire sensors is made either after power on or by the button “Scan”. All found sensors are shown in ascending order refer to their unique ID number.

It is possible to lock a 1-Wire sensor in a specific position. To do this all sensors should be added one by one. After every addition, a new scan should be made and a newly found sensor should be locked in its position. If all sensors are locked, removing one “in the middle” will not change the positions of other sensors after reset. This option is very useful when TCG140-4 is used as a part of a monitoring and control system managed by HTTP API commands.

7.2.2.3. MODBUS RTU communication setup

TCG140-4 supports MODBUS RTU over the RS-485 interface. All sensors connected to this interface should work with the same communication settings.

By default, TCG140-4 works with the standard for MODBUS RTU settings – 19200, E, 1.

In the right part of the section, there is a tool for scan the MODBUS RTU interface. To optimize scan time, the appropriate sensor time-out and address segment should be set up, after this, the button “Save” on the bottom of the page should be pressed.

7.2.2.4. MODBUS RTU sensors

| Pos | Sensor address | Data type | Data order | Register 1 | | Register 2 | | Response time-out, ms |
|-----|----------------|-----------|------------|------------|-----------|------------|-----------|-----------------------|
| | | | | Address | Raw value | Address | Raw value | (10-500) ms |
| 5 | 1 | float | MSW first | 100 | 28.880 | | ... | 100 |
| 6 | 2 | float | MSW first | 100 | 28.236 | 102 | 54.436 | 100 |
| 7 | 0 | float | MSW first | 100 | ... | | ... | 100 |
| 8 | 0 | float | MSW first | 100 | ... | | ... | 100 |

Max response time-out: 200
Polling time: 1000

Save

[Sensor setup tool](#)

TCG140-4 supports Teracom and third-party MODBUS RTU sensors.

For every sensor, the appropriate MODBUS RTU address, register address, data order, and data type should be set. All changes should be saved. If the settings are OK in the columns “Raw value” the right data will be shown.

TCG140-4 supports MODBUS RTU sensors with response time-out between 10 and 500ms. The default response time-out for a new sensor is 100ms. It is recommended to use the minimum response time guaranteed by the sensor’s manufacturer. The sum of chosen response time-out for every sensor forms the maximum response time-out for the system.

The polling time is the time between two sequential readings of the same sensor. The chosen polling time determines the system's time of reaction. By default, it is 1 second.

Important: The maximum response time-out can’t be lower than the polling time.

All further processing of the raw data is in the following formats:

- Float-point for data types float, 16-bit unsigned integer and 16-bit signed integer. The float-point format is with 24-bit mantissa.
- Float-point or integer for data types 32-bit unsigned integer and 32-bit signed integer. The float-point format is with 24-bit mantissa. For the integer format, the calculations with multiplier and offset are truncated.

7.2.2.5. Sensor setup tool

The link for the tool is available at the bottom of the Modbus RTU sensors paragraph. It can be used for sensor communication setup changes or just to read information from a register.

7.2.2.5.1. Communication setup

The section is similar to the general MODBUS RTU communication setup. The only new field is the sensor address.

The changes of settings in this section are not memorized and don't change the general settings of TCG140-4.

The screenshot shows the 'Communication setup' interface. It includes several input fields: 'Bit rate' (19200), 'Parity' (even), 'Stop bits' (1), 'Time-out' (100), 'First address' (1), 'Last address' (247), and 'MB Address' (1). A 'Scan' button is present, and below it, the results are displayed: 'Found: 1 sensors with following addresses: 3'.

7.2.2.5.2. Sensor communication register setup

This part of the tool is used to check and change the status of the communication registers of the sensor.

The screenshot shows the 'Sensor communication register setup' interface. It has three rows of input fields: 'Bit rate register #' (11) with 'Value' (19200), 'Parity, stop register #' (12) with 'Value' (1), and 'Address register #' (10) with 'Value' (3). There are 'Read' and 'Write' buttons, and a status message 'Transfer successful.' is shown at the bottom.

7.2.2.5.3. Sensor register check

The screenshot shows the 'Sensor registers check' interface. It includes input fields for 'Start address' (100), 'Data type' (float), 'Number of registers' (2), 'Data order' (MSW first), and 'Value' (27.775). There are 'Read' and 'Write' buttons, and a status message 'Transfer successful.' is shown at the bottom.

This part of the tool is used for general sensor register check.

7.2.3. Input/Output

7.2.3.1. Sensors

| Sensors | | | | | |
|----------|-------------|------|------------|--------|--|
| Sensor # | Description | Unit | Multiplier | Offset | |
| S1 | S1:TST1xx | °C | 1.000 | 0.00 | |
| | | --- | | | |
| S2 | S2 | --- | | | |
| | | --- | | | |
| S3 | S3 | --- | | | |
| | | --- | | | |
| S4 | S4 | --- | | | |
| | | --- | | | |
| S5 | S5 | °C | 1.000 | 0.00 | |
| | | %RH | 1.000 | 0.00 | |
| S6 | S6 | --- | | | |
| | | --- | | | |
| S7 | S7 | --- | | | |
| | | --- | | | |
| S8 | S8 | --- | | | |
| | | --- | | | |

For every sensor, a description, up to 15 symbols can be set. These descriptions will appear in the monitoring page, conditions page, XML/JSON data, SMS, and e-mail alerts.

For some sensors, fields “Unit”, “Multiplier” and “Offset” are available to convert the raw values into meaningful units. The scaled value is calculated by:

$$SV[Un] = RV * MU + OF$$

Where:

SV – scaled (displayed) value;

Un – unit;

RV – raw value from the sensor;

MU – multiplier;

OF – offset.

7.2.3.2. Digital inputs

| Digital inputs | | | | | |
|----------------|-----------------|-----------|------------|--|--|
| Input # | Description | Low level | High level | | |
| DI1 | Digital Input 1 | CLOSED | OPEN | | |
| DI2 | Digital Input 2 | CLOSED | OPEN | | |

For every digital input, a description, up to 15 symbols and states up to 15 symbols can be set. These descriptions will appear in the monitoring page, conditions page, XML/JSON data, SMS, and e-mail alerts.

7.2.3.3. Analog inputs

| Analog inputs | | | | | | |
|---------------|----------------|------|------------|--------|---------|---|
| Input # | Description | Unit | Multiplier | Offset | Type | |
| A11 | Analog Input 1 | V | 1.000 | 0.0000 | | |
| A12 | Analog Input 2 | V | 1.000 | 0.0000 | | |
| A13 | Analog Input 3 | V | 1.000 | 0.0000 | voltage | ▼ |
| A14 | Analog Input 4 | V | 1.000 | 0.0000 | voltage | ▼ |

For every analog input, a description, up to 15 symbols can be set. These descriptions will appear in the monitoring page, conditions page, XML/JSON data, SMS, and e-mail alerts.

For every analog input, fields “Unit”, “Multiplier” and “Offset” are available to convert the raw voltage/current into meaningful engineering units. The scaled value is calculated by:

$$SV[Un] = RV * MU + OF$$

Where:

SV – scaled (displayed) value;

Un – unit;

RV – raw voltage from the source;

MU – multiplier;

OF – offset.

Example:

For humidity sensor HIH-4000-003 following data (from the datasheet) is available:

VOUT = 0.826 at 0% RH

VOUT = 3.198 at 75.3% RH

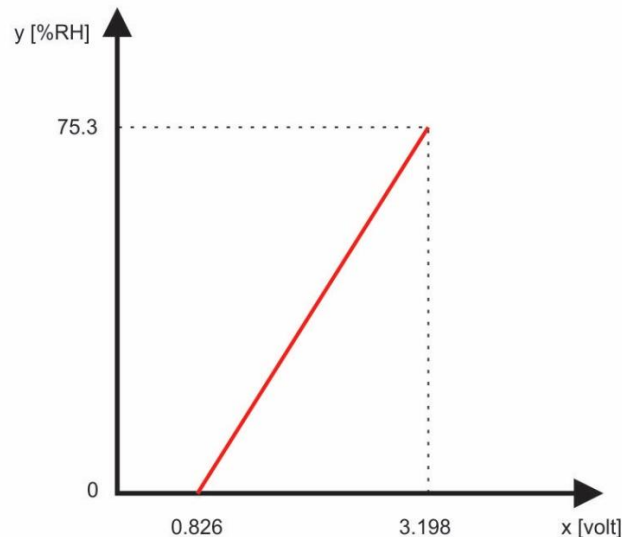

The raw values are voltages on the sensor’s output. Actually, we need to know relative humidity (scaled value) not voltages. The two relations are enough to calculate multiplier and offset. When we know them, we can calculate what relative humidity corresponds to every voltage in the working range.

The multiplier (MU) is calculated as $\Delta Y/\Delta X$, for this sensor $\Delta RH\%/\Delta V$:

$$MU = (75.3 - 0)/(3.198-0.826) = 75.3/2.372 = 31.745 \%RH/V$$

The offset is calculated from the already known multiplier and relation for one of the points:

$$OF = MU * (0 - VOUT1) + RH1 = 31.745*(0-0.826) + 0 = 31.745*(-0.826) = -26.22$$

The same result can be calculated for the second point:

$$OF = MU * (0 - VOUT2) + RH2 = 31.745*(0-3.198) + 75.3 = -101.52 + 75.3 = -26.22$$

For this sensor, the formula will look like this:

$$SV = RV * 31.745 - 26.22$$

Check for VOUT = 0.826 V (0%RH):

$$SV = 0.826 * 31.745 - 26.22 = 26.22 - 26.22 = 0 \%RH$$

The same value is written in the datasheet.

7.2.3.4. Relay outputs

| Relay outputs | | | | | |
|---------------|-------------|-----------------|----------------|-----------------------|--|
| Relay # | Description | Pulse (seconds) | Activated from | Action on alarm/event | |
| R1 | Relay 1 | 0.1 | SMS/HTTP API | Turn on | |
| R2 | Relay 2 | 0.2 | SMS/HTTP API | Turn on | |
| R3 | Relay 3 | 0.3 | SMS/HTTP API | Turn on | |
| R4 | Relay 4 | 0.4 | SMS/HTTP API | Turn on | |

Relays state after restart: Last state

For every relay, a description, up to 15 characters can be set. These descriptions will appear in the monitoring page, XML/JSON data, SMS and e-mail alerts.

The pulse duration can be different for every relay. The resolution is 0.1 second, the maximum pulse value is 3600 seconds.

All relays can be activated either remotely by SMS/HTTP API or locally from the status of a monitored parameter. This setting is made from the “Activated from” drop-down menu, the possible options are:

- **SMS/HTTP** - by selecting this option the relay outputs can be activated by SMS from an authorized number or by sending HTTP API commands;
- **Local activation.**

For local activation, alarm conditions for different sources are used. They are set up in section “Setup->Conditions”. To assign a parameter to the relay, the following choices are possible:

- **S?** – “S” stands for “Sensor 1-Wire”. The relay is activated from the value measured from the specified 1-Wire sensor and rules for ranges specified in “Setup->Conditions”. Question mark masks a number from 1 to 8;
- **Analog input?**. The relay is activated from the value measured by specified analog input and rules for ranges specified in “Setup->Conditions”. Question mark masks a number from 1 to 4;
- **Digital input?**. The relay follows the state of the specified digital input. Question mark masks a number from 1 to 2;
- **Any alarm.** The relay is activated on any alarm condition.

All changes in the above sections are saved by pressing the “Save” button.

7.2.4. Conditions

This section is used for parameterization of trigger and alert conditions for sensors, analog, and digital inputs.

7.2.4.1. Sensors and analog inputs

| Sensors | | | | | | | If out of range | | | |
|---------|-------------|------|-----------------|-------|-------|------|--------------------------|--------------------------|--------------------------|--------------------------|
| # | Description | Type | Parameter | Min | Max | Hys | mail | sms | post | mqtt |
| 1 | S1:TSH2xx | 1W | Temperature, °C | -40.0 | 31.0 | 0.2 | <input type="checkbox"/> | <input type="checkbox"/> | <input type="checkbox"/> | <input type="checkbox"/> |
| | | | Humidity, %RH | 0.0 | 100.0 | 10.0 | <input type="checkbox"/> | <input type="checkbox"/> | <input type="checkbox"/> | <input type="checkbox"/> |
| 2 | S2 | 1W | --- | --- | --- | --- | <input type="checkbox"/> | <input type="checkbox"/> | <input type="checkbox"/> | <input type="checkbox"/> |
| | | | --- | --- | --- | --- | <input type="checkbox"/> | <input type="checkbox"/> | <input type="checkbox"/> | <input type="checkbox"/> |
| 3 | S3 | 1W | --- | --- | --- | --- | <input type="checkbox"/> | <input type="checkbox"/> | <input type="checkbox"/> | <input type="checkbox"/> |
| | | | --- | --- | --- | --- | <input type="checkbox"/> | <input type="checkbox"/> | <input type="checkbox"/> | <input type="checkbox"/> |
| 4 | S4 | 1W | --- | --- | --- | --- | <input type="checkbox"/> | <input type="checkbox"/> | <input type="checkbox"/> | <input type="checkbox"/> |
| | | | --- | --- | --- | --- | <input type="checkbox"/> | <input type="checkbox"/> | <input type="checkbox"/> | <input type="checkbox"/> |
| 5 | S5 | MB | --- | --- | --- | --- | <input type="checkbox"/> | <input type="checkbox"/> | <input type="checkbox"/> | <input type="checkbox"/> |
| | | | --- | --- | --- | --- | <input type="checkbox"/> | <input type="checkbox"/> | <input type="checkbox"/> | <input type="checkbox"/> |
| 6 | S6 | MB | --- | --- | --- | --- | <input type="checkbox"/> | <input type="checkbox"/> | <input type="checkbox"/> | <input type="checkbox"/> |
| | | | --- | --- | --- | --- | <input type="checkbox"/> | <input type="checkbox"/> | <input type="checkbox"/> | <input type="checkbox"/> |
| 7 | S7 | MB | --- | --- | --- | --- | <input type="checkbox"/> | <input type="checkbox"/> | <input type="checkbox"/> | <input type="checkbox"/> |
| | | | --- | --- | --- | --- | <input type="checkbox"/> | <input type="checkbox"/> | <input type="checkbox"/> | <input type="checkbox"/> |
| 8 | S8 | MB | --- | --- | --- | --- | <input type="checkbox"/> | <input type="checkbox"/> | <input type="checkbox"/> | <input type="checkbox"/> |
| | | | --- | --- | --- | --- | <input type="checkbox"/> | <input type="checkbox"/> | <input type="checkbox"/> | <input type="checkbox"/> |

Return notification Notification delay (seconds) (0-3600)

| Analog inputs | | | | | | | If out of range | | | |
|---------------|----------------|-----------|-------|-------|-------|--------------------------|--------------------------|--------------------------|-------------------------------------|--|
| # | Description | Dimension | Min | Max | Hys | mail | sms | post | mqtt | |
| 1 | Analog Input 1 | V | 0.000 | 5.000 | 1.000 | <input type="checkbox"/> | <input type="checkbox"/> | <input type="checkbox"/> | <input checked="" type="checkbox"/> | |
| 2 | Analog Input 2 | V | 0.000 | 5.000 | 1.000 | <input type="checkbox"/> | <input type="checkbox"/> | <input type="checkbox"/> | <input checked="" type="checkbox"/> | |
| 3 | Analog Input 3 | V | 0.000 | 5.000 | 1.000 | <input type="checkbox"/> | <input type="checkbox"/> | <input type="checkbox"/> | <input checked="" type="checkbox"/> | |
| 4 | Analog Input 4 | V | 0.000 | 5.000 | 1.000 | <input type="checkbox"/> | <input type="checkbox"/> | <input type="checkbox"/> | <input checked="" type="checkbox"/> | |

For every sensor two types of fields are presented – one for the trigger conditions (“Min”, “Max”, and “Hys.”) and another one for the wanted action.

“Min” and “Max” indicate the border of the working range for the monitored parameter. The “Max” trigger condition occurs when the value exceeds the trigger set point. The “Min” trigger condition occurs when the value is lower than the trigger set point. In both cases, the monitored parameter goes out of range.

Coming back in range for the observed parameter is considered when the value goes higher than (Min + Hys) or lower than (Max – Hys). Hysteresis (“Hys”) is used to prevent excessively triggering when the value fluctuates around the trigger point.

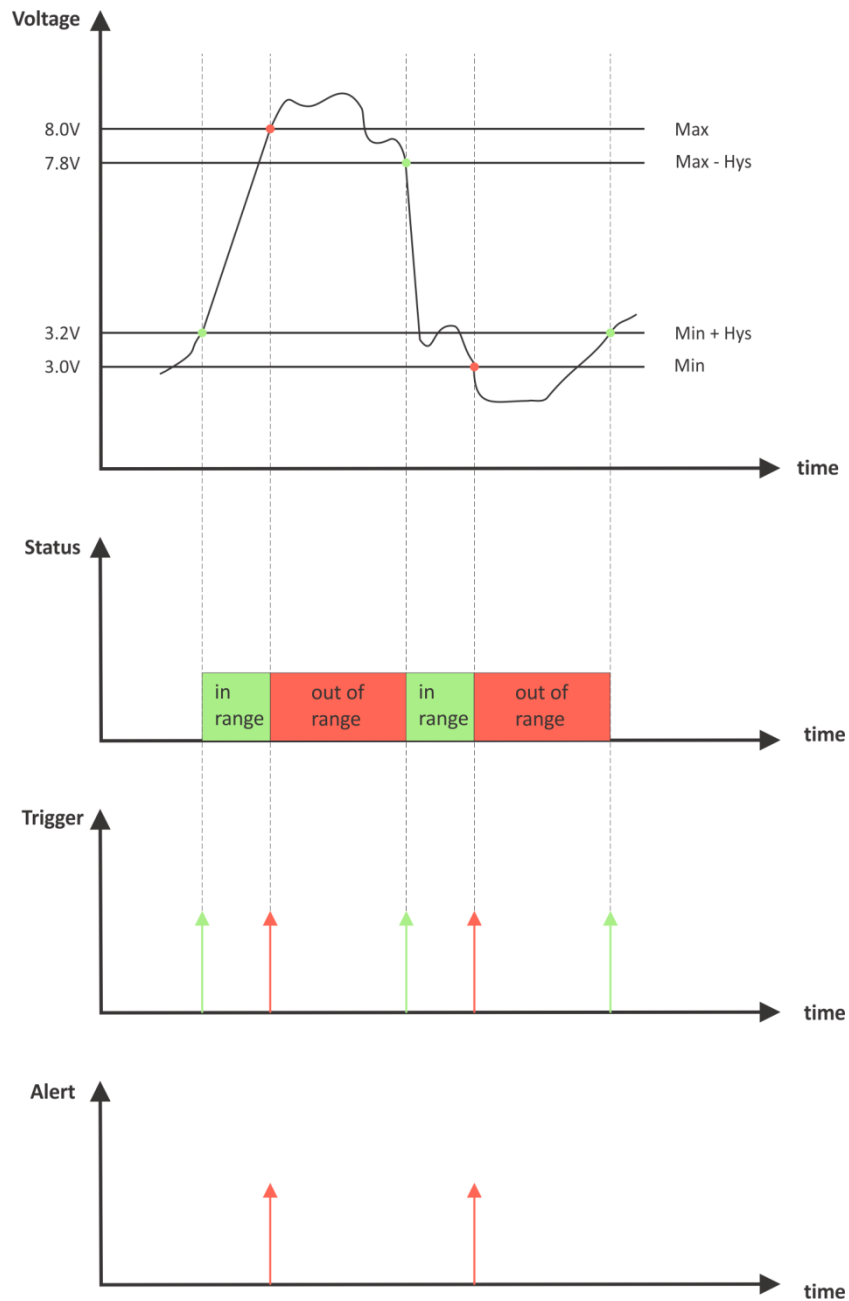

Example:

TCG140-4, TST100, and an appropriate heater are used to control the room temperature. The wanted minimum temperature is 19°C. The initial temperature is 17°C.

TST100 is assigned on the first position for 1-Wire sensors.

For Relay1 local activation from Sensor1 is set.

Following parameters are set for Sensor1: Min=19, Max=100 and Hys=0.5.

| Sensors | | | | | | | If out of range | | | |
|---------|-------------|------|-----------------|-----|-----|-----|-------------------------------------|-------------------------------------|--------------------------|--------------------------|
| # | Description | Type | Parameter | Min | Max | Hys | mail | sms | post | mqtt |
| 1 | S1:TSH2xx | 1W | Temperature, °C | 19 | 100 | 0.5 | <input checked="" type="checkbox"/> | <input checked="" type="checkbox"/> | <input type="checkbox"/> | <input type="checkbox"/> |

When the module is switched on, Relay1 is immediately activated because the monitored temperature is out of range. This switches the heater on. The temperature is going higher.

When temperature reaches 19.5°C (19.0 + 0.5) it goes in range (trigger condition) and Relay1 is deactivated. The heater is switched off.

The temperature falls and when it reached 19°C it goes out of range (trigger and alert conditions). The relay is activated (heater is switched on) and e-mail is sent.

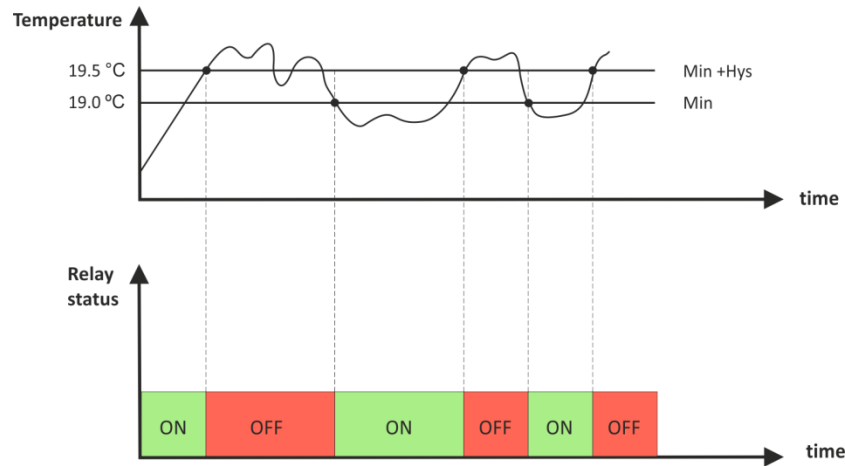

The “Max” value is set far enough from the wanted temperature to avoid trigger/alert conditions around it.

For every sensor or analog input, there are 3 independent ways of alert when there is an alarm condition – email, SMS, and post (HTTP Post with XML/JSON file). Each alarm notification method is activated by a checkbox.

Globally for all sensors and for all analog inputs, there is a checkbox “Return notification”. If this option is chosen there will be a notification also when the parameter returns in range.

Globally for all sensors and for all analog inputs, there is a “Notification delay” parameter. It is very useful as a filter for short alarm conditions.

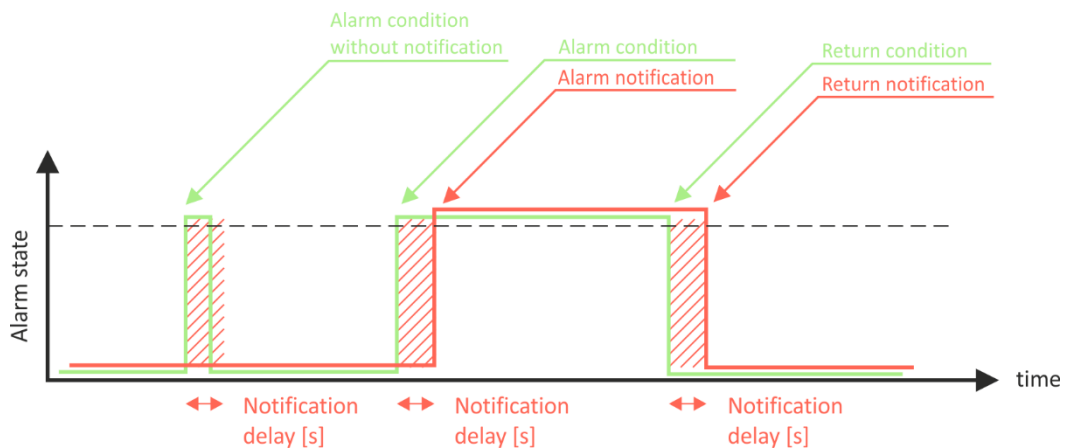

7.2.4.2. Digital inputs

| Digital inputs | | On active alarm | | | | | | | |
|----------------|-----------------|-----------------|--------------------|---------------------------|---------------------------|--------------------------|--------------------------|--------------------------|-------------------------------------|
| # | Description | Current state | Select alarm state | Low to high delay, 0-3600 | High to low delay, 0-3600 | mail | sms | post | mqtt |
| 1 | Digital Input 1 | OPEN | CLOSED | 0.0 | 0.0 | <input type="checkbox"/> | <input type="checkbox"/> | <input type="checkbox"/> | <input checked="" type="checkbox"/> |
| 2 | Digital Input 2 | OPEN | CLOSED | 0.0 | 0.0 | <input type="checkbox"/> | <input type="checkbox"/> | <input type="checkbox"/> | <input checked="" type="checkbox"/> |

Return notification Notification delay (seconds) (0-3600)

For every digital input, the alarm state should be chosen. The texts are already set on the “Input/output” page.

When the input goes in alarm state 4 independent way of the alert are possible – email, SMS, post (HTTP Post with XML/JSON file) and MQTT publish. Each alarm notification method is activated by a checkbox.

Globally for all digital inputs, there is a checkbox “Return notification”. If this option is chosen there will be a notification also when the parameter returns in range.

Globally for all digital inputs, there is a “Notification delay” parameter. It is useful as a filter for short alarm conditions.

In the time when the input is in an alarm state, on the „Monitoring page“, the appropriate input will be colored in red.

There are two delays - low-to-high and high-to-low for digital input change. These delays are added to the standard delay of 30ms. They have 0.1-second resolution and by default are zero.

These options can be used for additional filtering.

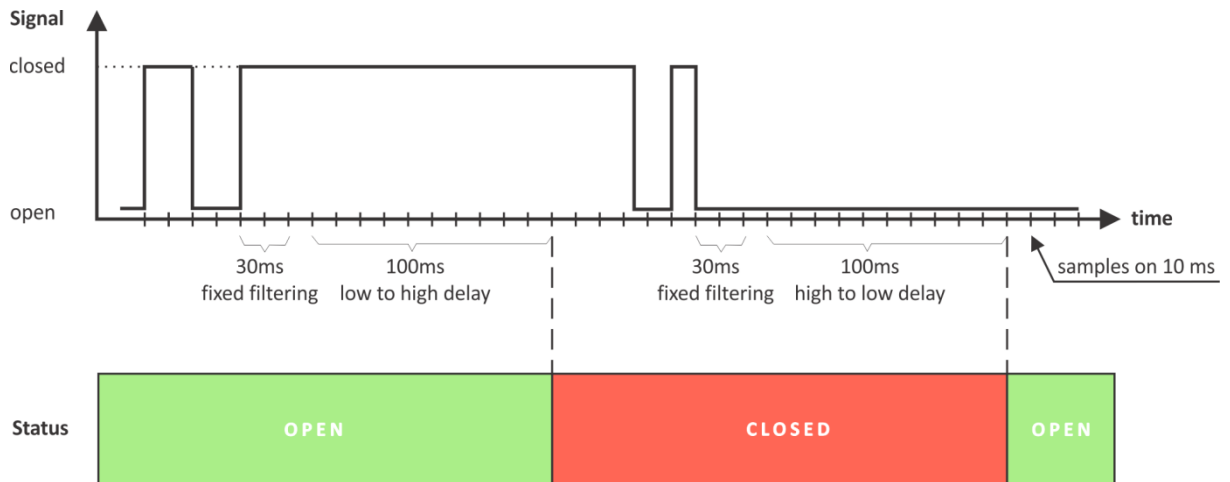

On the picture above low-to-high and high-to-low delays are set to 0.1 seconds.

7.2.5. System

The page for some general settings.

7.2.5.1. System status

| System status | | | |
|--------------------------|-----------------|-------------------------|--------------------------|
| Network registration | Yes | Enable data in roaming | <input type="checkbox"/> |
| Data connection | Yes | Data in roaming | No |
| Signal strength | -75dBm(61%) | Service | 1,FDD LTE,LTE BAND 7 |
| Service provider | A1 BG A1 BG | IP address | 10.73.249.184 |
| Mobile Country Code(MCC) | 284 | Location Area Code(LAC) | 28201 |
| Mobile Network Code(MNC) | 01 | Cell ID(CID) | 46743 |
| IMEI | 862632040544279 | MFW version | EG91EFBR06A07M4G |

There is information about the general status of the module here.

The only possible setting here is the “Data in roaming” checkbox. By default, it is disabled to avoid extra charges for data transfer in roaming.

If you are using another operator's card, you must activate “Data in roaming”. Otherwise, you will not be able to use all data services – emails, HTTP Post, NTP, etc.

7.2.5.2. Data connection setup

| Data connection setup | |
|-----------------------|---------------------------------------|
| APN | <input type="text" value="internet"/> |
| Username | <input type="text"/> |
| Password | <input type="text"/> |
| Network | <input type="text" value="AUTO"/> |

This setting can be different for each mobile operator. By default, APN (Access Point Name) is “internet”. Some mobile operators may require also a username and password.

The network determines the mobile service type – 2G, 3G, or 4G LTE. By default, it is AUTO – the highest possible generation service will be used in the current position.

7.2.5.3. Mobile network connection reset

For areas with low signal strength or where the mobile network frequently drops/blocks, automatic restarting of the network connection can be used. This could prevent permanently losing the connection with the device.

The automatic restart will be done once per day.

By default, the automatic restart is disabled.

| Mobile network connection reset | |
|------------------------------------|---------------------------------------|
| Automatic network connection reset | <input type="text" value="Disable"/> |
| Time of the reset(hh:mm:ss) | <input type="text" value="00:00:00"/> |

7.2.5.4. General setup

| General setup | | | |
|-------------------|------------------------------------------------------|----------------|-------------------------------------|
| Temperature units | <input type="text" value="Celsius"/> | 1-Wire sensors | <input checked="" type="checkbox"/> |
| Pressure units | <input type="text" value="hPa"/> | Modbus sensors | <input checked="" type="checkbox"/> |
| Host name | <input type="text" value="TCG140-4"/> | Analog inputs | <input checked="" type="checkbox"/> |
| Writing mode | <input type="text" value="left-to-right"/> | Digital inputs | <input checked="" type="checkbox"/> |
| System name | <input type="text" value="TCG140-4"/> | Relay outputs | <input checked="" type="checkbox"/> |
| System location | <input type="text" value="Location"/> | | |
| System contact | <input type="text" value="info@teracomsystems.com"/> | | |

The section is for some general settings.

The temperature and pressure units can be changed with preferable ones.

Writing mode change the alignment in the WEB interface and SMS.

Hostname, System name, System location and System contact are sent in XML/JSON files and can be used for flexible identification of the device. These parameters can be also included in the body of the e-mails.

The checkboxes on the right define what to see on the “Monitoring page”. By default, they all are enabled.

7.2.5.5. Device restart

In this section, there are buttons for device restart and reset to factory default settings.

Device restart

7.2.6. NTP

Time setup

Time configuration

NTP server IP/URL

Time zone

Period (h)

If not found (h)

Set time

Uptime

Uptime 0days,00:17:18

NTP test

Current time 01.07.2021,14:06:10

Last updated ---

Status

Internal RTC (real-time clock) of the module can be set either manually or automatically.

For automatic clock synchronization, the module supports NTP (Network Time Protocol) and all necessary parameters for automatic synchronization are available in this section.

The clock synchronization is made on the set “Period”. If the attempt was not successful, the next synchronization will be on “If not found” time.

Pressing the “Save and synchronize” button initiates time synchronization. The information for “Status” in the blue box is very useful for the availability of the time server and the Internet at all.

The current system time is sent in an XML/JSON file when HTTP Post is enabled.

By default, NTP synchronization is enabled, server – time.google.com:123, Time zone 00.00 and period of 12 hours.

The settings and service at all can be checked with the available tools in the NTP Test section.

7.3. Services

7.3.1. SMTP

This page is used to enter valid SMTP settings for email alerts and recipients' addresses.

7.3.1.1. SMTP setup

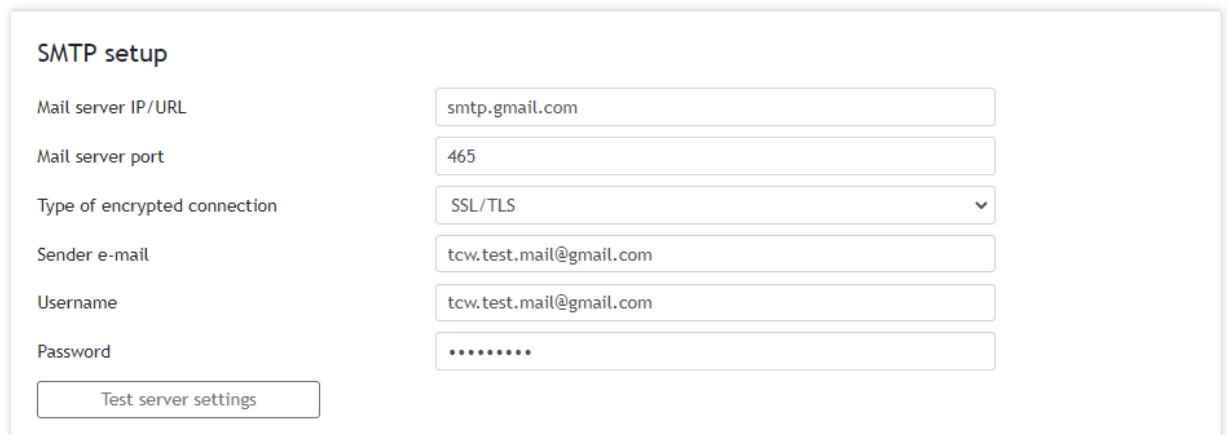

The screenshot shows a form titled "SMTP setup" with the following fields and values:

| | |
|------------------------------|-------------------------|
| Mail server IP/URL | smtp.gmail.com |
| Mail server port | 465 |
| Type of encrypted connection | SSL/TLS |
| Sender e-mail | tcw.test.mail@gmail.com |
| Username | tcw.test.mail@gmail.com |
| Password | |

At the bottom of the form is a button labeled "Test server settings".

The mail server address can be set either by hostname (smtp.gmail.com) or by IP address.

The e-mails can be sent with or without an encrypted connection.

The default SMTP port without encryption is 25. Almost all ISP's block this port to avoid hacker attacks. Ask your ISP for details.

The only supported method for encrypted connection from most of the public email servers is TLS. TCG140-4 supports TLS 1.0, TLS 1.1, and TLS 1.2 with a lot of cipher suites. This ensures successful operation with almost all public servers.

Be careful with the terms SSL, TLS, and STARTTLS used in email server settings, supplied by the provider. Some providers as Gmail uses SSL instead of TLS and TLS instead of STARTTLS. This can provoke mismatches with the port number. For example, the right settings for Gmail are:

- TLS on port 465 or
- STARTTLS on port 587.

Sender e-mail, username, and password are standard authentication details. For most SMTP servers, the sender's e-mail and username are the same.

There is a button for server settings test with feedback. In this test sender and recipient of the e-mail is the same.

7.3.1.2. Alarm destination

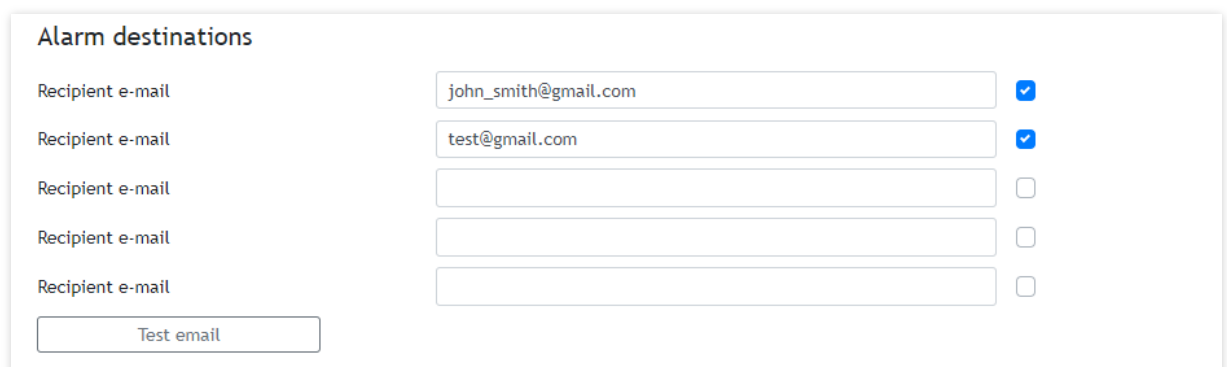

The screenshot shows a form titled "Alarm destinations" with the following fields and values:

| | | |
|------------------|----------------------|-------------------------------------|
| Recipient e-mail | john_smith@gmail.com | <input checked="" type="checkbox"/> |
| Recipient e-mail | test@gmail.com | <input checked="" type="checkbox"/> |
| Recipient e-mail | | <input type="checkbox"/> |
| Recipient e-mail | | <input type="checkbox"/> |
| Recipient e-mail | | <input type="checkbox"/> |

At the bottom of the form is a button labeled "Test email".

Up to 5 email recipients can be set. Every recipient can be activated independently by a checkbox.

7.3.1.3. E-mail details

| Subject, header and footer variables | Body variables |
|--------------------------------------|---------------------------|
| #N System Name | #D Sensor Description |
| #L System Location | #V Measured Value |
| #C System Contact | #U Unit of measured value |
| #A IP Address of device | #T Time stamp of message |
| | #W LoW limit |
| | #G HiGh limit |

The subject, body header, body, and body footer can be customized. For this customization, a set of keys is used. All they are described on the page.

7.3.2. Logger

Logger setup

| | | |
|-----------------------------------|-----------------|---|
| Logger | Enable | ▼ |
| Logger mode | Time&Alarm mode | ▼ |
| Logger records synchronization | Disable | ▼ |
| Logging period (60-3600), seconds | 60 | |
| Sync to the minute, (00-59) | 0 | |
| Log interval, minutes | 15 | ▼ |

CSV Post setup

| | | |
|--------------------------------------------|--------------------------------------------------|------------------|
| CSV HTTP/HTTPS Post | Enable | ▼ |
| Post mode | http | ▼ |
| Add IMEI as a suffix to the URL | Enable | ▼ |
| Server | www.teracomsystems.com/temp/TCG140-4/postlog.php | /862632040544279 |
| CSV Post period (h) | 12h | ▼ |
| Sync time | 00:00:00 | |
| Add ID header at the beginning of CSV file | Enable | ▼ |
| Add EOF at the end of CSV file | Enable | ▼ |

Post test result

Post test log Force CSV Post Download full log

The logger works in three modes – Time, Alarm, and Time&Alarm. The mode specifies what initiates a record in the logger’s memory.

In Time mode, records are made periodically on the “Logging period”. In Alarm mode, records are made on any alarm condition. In Time&Alarm mode, a mix of both conditions for records is used.

The logging period determines the time between two records. It is good to remember that by reducing the logging period, we increase the resolution, but we also reduce the past period for which we have records.

The logger records can be synchronized with a specific minute in an hour. Synchronization is very useful when monitoring electricity, water, gas meters, etc. The logging period can be chosen from a drop-down menu between 1 and 60 minutes. The field „Sync to the minute“ determines which minute of every hour is used for synchronization. Although any minute can be selected, it is better to use the default value - 00.

Example:

The current settings are:

- Current time = 09:12
- Logger record sync = Enable;
- Sync to the minute = 00;
- Logging period = 15 minutes.

The settings determine 4 records per hour in HH:00, HH:15, HH:30, and HH:45.

The device is powered up.

The first record will be immediately after power-up - 09:12. The next records will be in 09:15, 09:30, 09:45, 10:00, 10:15, etc.

There are two ways to reach the logger records:

- download of the full log file, using “Download full log” in the WEB interface;
- periodical upload the last unsent records to the dedicated HTTP server.

The records can be uploaded in CSV file format with HTTP/HTTPS Post.

The period of the CSV Post can be chosen from the menu between 1 and 24 hours. If you enable this service, take care of the real-time clock (NTP service).

The “Server” for CSV Post can be domain or IP address but take care of DNS settings.

“Sync time” is a moment in the day when a period of CSV Post is synchronized.

Example:

The current time is 19:31, the CSV Post period is 3 hours and the Sync time is 9:00.

To synchronize the logger to 9:00 it means that time for uploads will be: 09:00, 12:00, 15:00, 18:00, 21:00, 24:00, 03:00 and 06:00. The first upload, after enabling the logger in 19:31, will be at 21:00.

The button “Force CSV Post” initiates the upload of recorded information from the previous periodical upload up to now.

Identification header adds Hostname, System name, System location, and System contact at the beginning of every CSV file. This option helps to identify reports in systems that use CSV files only.

By default, the logger is disabled.

More about the logger can be found in the Data logger section.

7.3.3. XML/JSON file HTTP Post

XML/JSON HTTP Post setup

| | | | |
|----------------------|--------------------------|-------------------------------------|------|
| HTTP post | Enable | ▼ | |
| Post mode | https | ▼ | |
| Data format | XML | ▼ | |
| Server 1 | http(s):// | www.teracomsystems.com/temp/post/pc | Test |
| Server 2 | http(s):// | | Test |
| Period ⓘ | 00:05:00 | | |
| Connect on any alarm | <input type="checkbox"/> | | |
| Key | | | |
| Process answer | No | ▼ | |

HTTP Post is used for periodically upload of an XML/JSON file to a server by HTTP/HTTPS requests (Post method). The file contains the current status of all monitored parameters and extra system information. The file format is chosen from the drop-down menu.

The HTTP servers can be addressed either by domain name or IP address.

The "Period" can be set between 1 min and 48 hours. This parameter can be changed remotely by a command. The "Period" determines at what time the control software receives up-to-date information from TCG140-4 and can, therefore, make changes to some of the parameters. The shorter is "Period", the closer to the real-time operation is the system. On the other hand, as shorter is the "Period" as higher is the data traffic through the mobile network.

If the checkbox "Connect on any alarm" is selected, HTTP Post will be sent on any alarm.

The "Key" field is user-defined. Its value is available in XML/JSON file and can be used for device identification.

If "Process Answer" is enabled, TCG140-4 will execute the commands, sent by the remote server as an answer of HTTP/HTTPS Post.

More about HTTP/HTTPS Post can be read in the HTTP API section.

7.4. MQTT

Device supports MQTT 3.1.1. This page is for the MQTT settings.

7.4.1. MQTT General setup

MQTT setup

| | | |
|----------------------------|---------------------------------------|-------------------------------------|
| MQTT | <input type="text" value="Enable"/> | |
| Data format | <input type="text" value="JSON"/> | |
| MQTT mode | <input type="text" value="unsecure"/> | |
| Server | <input type="text"/> | <input type="button" value="Test"/> |
| Port | <input type="text" value="1883"/> | |
| Username | <input type="text"/> | |
| Password | <input type="text"/> | |
| Period <small>i</small> | <input type="text" value="00:05:00"/> | |
| Client ID <small>i</small> | <input type="text" value="TCG140-4"/> | |
| Name topic | <input type="text" value="TCG140-4"/> | |

7.4.2. MQTT Sensors topic

Sensors

Sensors topic name

| Sensor # | Topic | Publish value | Publish state |
|----------|---------------------------------|-------------------------------------------|-------------------------------------------|
| S1 | <input type="text" value="11"/> | <input type="checkbox"/> <small>i</small> | <input type="checkbox"/> <small>i</small> |
| | <input type="text" value="12"/> | <input type="checkbox"/> <small>i</small> | <input type="checkbox"/> <small>i</small> |
| S2 | <input type="text" value="21"/> | <input type="checkbox"/> <small>i</small> | <input type="checkbox"/> <small>i</small> |
| | <input type="text" value="22"/> | <input type="checkbox"/> <small>i</small> | <input type="checkbox"/> <small>i</small> |
| S3 | <input type="text" value="31"/> | <input type="checkbox"/> <small>i</small> | <input type="checkbox"/> <small>i</small> |
| | <input type="text" value="32"/> | <input type="checkbox"/> <small>i</small> | <input type="checkbox"/> <small>i</small> |
| S4 | <input type="text" value="41"/> | <input type="checkbox"/> <small>i</small> | <input type="checkbox"/> <small>i</small> |
| | <input type="text" value="42"/> | <input type="checkbox"/> <small>i</small> | <input type="checkbox"/> <small>i</small> |
| S5 | <input type="text" value="51"/> | <input type="checkbox"/> <small>i</small> | <input type="checkbox"/> <small>i</small> |
| | <input type="text" value="52"/> | <input type="checkbox"/> <small>i</small> | <input type="checkbox"/> <small>i</small> |
| S6 | <input type="text" value="61"/> | <input type="checkbox"/> <small>i</small> | <input type="checkbox"/> <small>i</small> |
| | <input type="text" value="62"/> | <input type="checkbox"/> <small>i</small> | <input type="checkbox"/> <small>i</small> |
| S7 | <input type="text" value="71"/> | <input type="checkbox"/> <small>i</small> | <input type="checkbox"/> <small>i</small> |
| | <input type="text" value="72"/> | <input type="checkbox"/> <small>i</small> | <input type="checkbox"/> <small>i</small> |
| S8 | <input type="text" value="81"/> | <input type="checkbox"/> <small>i</small> | <input type="checkbox"/> <small>i</small> |
| | <input type="text" value="82"/> | <input type="checkbox"/> <small>i</small> | <input type="checkbox"/> <small>i</small> |

7.4.3. MQTT Analog inputs topic

Analog inputs

Analog inputs topic name

| Analog input # | Topic | Publish value | Publish state |
|----------------|--------------------------------|-----------------------------------|-----------------------------------|
| AI1 | <input type="text" value="1"/> | <input type="checkbox"/> <i>i</i> | <input type="checkbox"/> <i>i</i> |
| AI2 | <input type="text" value="2"/> | <input type="checkbox"/> <i>i</i> | <input type="checkbox"/> <i>i</i> |
| AI3 | <input type="text" value="3"/> | <input type="checkbox"/> <i>i</i> | <input type="checkbox"/> <i>i</i> |
| AI4 | <input type="text" value="4"/> | <input type="checkbox"/> <i>i</i> | <input type="checkbox"/> <i>i</i> |

7.4.4. MQTT Digital inputs topic

Digital inputs

Digital inputs topic name

| Digital input # | Topic | Publish value | Publish state |
|-----------------|--------------------------------|-----------------------------------|-----------------------------------|
| DI1 | <input type="text" value="1"/> | <input type="checkbox"/> <i>i</i> | <input type="checkbox"/> <i>i</i> |
| DI2 | <input type="text" value="2"/> | <input type="checkbox"/> <i>i</i> | <input type="checkbox"/> <i>i</i> |

7.5. Administration

7.5.1. Backup/Restore

Backup/Restore configuration

Select configuration file

TCG140-4 supports backup and restore of all user settings. All settings are saved in an XML backup file. This file can be used after this to restore the same settings on many devices. This is very useful for multiplying similar settings to a batch of modules.

7.5.2. FW update

Firmware update

Current FW version TCG140-4-v1.000

Select FW version

TCG140-4 supports firmware update over the WEB interface.

Download the latest firmware from www.teracomsystems.com, choose the file, and press the “upload” button.

Attention! Don’t turn off the power supply during the update. Turning off the power supply will damage the device.

8. Setup via SMS

TCG140-4 supports SMS commands for parameter change, status reports, and firmware update over the air. The commands will be executed only if they come from the phone numbers available in the section "SMS setup". The commands need different rights (master/user).

Below is a list of the supported SMS commands. Note that the underscore character “_” must be replaced by one space character.

- **Set new master number**

Rights: Master
Syntax: set_master_<number>
Where
<number> is a mobile number in the international format

Example

Command: set master +359885885885

Answer: You are the new master!

- **Set SMS users numbers** - this message is used to add/delete SMS users

Rights: Master
Syntax: set_sms_user_<user>:<number>
Where
<number> is a mobile number in the international format
<user> can be u1, u2, u3 or u4

Example

Command: set sms user u1:+359885887766

Answer: u1:+359885887766,u2,u3,u4

Command: set sms user u2:+359885999888

Answer: u1:+359885887766, u2:+359885999888,u3,u4

Command: set sms user u1:

Answer: u1, u2:+359885999888,u3,u4

- **Display SMS users numbers**

Rights: Master, Users
Syntax: display_sms_users

Example

Command: display sms users

Answer: m:+359885885885,u1:+359885887766,u2:+359885999888,u3,u4

- **Set email users** - this message is used to add/delete email users

Rights: Master
Syntax: set_email_user_<user>:<email>
Where
<email> - a valid email address
<user> can be e1, e2, e3, e4 or e5

Example

Command: set email user e1:mail1@teracomsystems.com

Answer: e1:mail1@teracomsystems.com

Command: set email user e2:mail2@teracomsystems.com

Answer: e2:mail2@teracomsystems.com
Command: set email user e2:
Answer: e2:

- **Display email users** - this message is used to request the email of a user

Rights: Master, Users
Syntax: display_email_<user>
Where
<user> can be one of: e1, e2, e3, e4 or e5

Example

Command: display email e1
Answer: e1:mail1@teracomsystems.com
Command: display email e2
Answer: e2:mail2@teracomsystems.com

- **Status of system** - requests main parameters of the device

Rights: Master, Users
Syntax: status_system

Example

Command: status system
Answer:
06.01.2021,16:09:06,4G=y,ss=80%,fw=1.00

- **Status of parameter** - requests status of digital input (di), analog input (ai), relay (r) and sensor(s)

Rights: Master, Users
Syntax: status_<param>
Where
<param> is one of: di1, di2, ai1, ai2, ai3, ai4, r1, r2, r3, r4, s11, s12, s21, s22, s31, s32, s41, s42, s51, s52, s61, s62, s71, s72, s81, s82

Example

Command: status di1
Answer: di1(Garage_door)=CLOSED
Command: status s22
Answer: s22(Office)=34.5%RH

- **Set a relay** - this message is used to switch on/off the selected relay output

Rights: Master, Users
Syntax: set_<relay>=<state>_[option]
Where
<relay> is r1, r2, r3 or r4
<state> is on, off
[option] -w

Example

Command: set r1=on
Answer: r1=on,r2=off,r3=off,r4=off
Command: set r1=off
Answer: r1=off,r2=off,r3=off,r4=off
Command: set r1=off,r2=on,r3=on,r4=on

Answer: r1=off,r2=on,r3=on,r4=on
Command: set r1=on -w
Answer: no answer
Command: set r2=off,r4=off -w
Answer: no answer

- **Set pulse a relay** - this message is used to pulse the selected relay output

Rights: Master, Users
Syntax: set_<pulse relay>=<state>_[option]
Where
< pulse relay > is pl1, pl2, pl3 or pl4
<state> is on
[option] -w

Example

Command: set pl1=on
Answer: r1=on,r2=off,r3=off,r4=on
Command: set pl1=on,pl2=on,pl3=on,pl4=on
Answer: r1=on,r2=on,r3=on,r4=on

Command: set pl1=on -w
Answer: no answer
Command: set pl1=on,pl4=on -w
Answer: no answer

- **Post URL** – sets URL for XML/JSON HTTP Post

Rights: Master
Syntax: set_purl=<link> or set_purl2=<link>
Where
<link> is the address of remote server (domain or IP)

Example

Command: set purl=www.teracomsystems.com:8801/posttest.php
Answer: purl=www.teracomsystems.com:8801/posttest.php,post=on,period=00:01:00
Command: set purl2=www.teracomsystems.com:8802/posttest.php
Answer: purl2=www.teracomsystems.com:8802/posttest.php,post=on,period=00:01:00

- **Status URL** – status URL's for XML/JSON HTTP Post

Rights: Master, User
Syntax: status_purl or status_purl2

Example

Command: status purl
Answer: purl=www.teracomsystems.com:8801/posttest.php,post=on,period=00:01:00
Command: status purl2
Answer: purl2=www.teracomsystems.com:8802/posttest.php,post=on,period=00:01:00

- **Post period in seconds** – sets XML/JSON HTTP Post period in seconds

Rights: Master
Syntax: set_pper=<value>

Where

<value> is a number between 60 and 172800 (seconds)

Example

Command: `set pper=120`

Answer: `post=off,period=00:02:00`

- **Post period in hh:mm:ss** – sets XML/JSON HTTP Post period in hh:mm:ss

Rights: Master

Syntax: `set_pperh=<value>`

Where

<value> is a number between 00:01:00 and 48:00:00

Example

Command: `set pper=00:05:00`

Answer: `post=off,period=00:05:00`

- **Post on** – sets XML/JSON HTTP Post on

Rights: Master

Syntax: `set_post=on`

Example

Command: `set post=on`

Answer: `post=on,period=00:02:00`

- **Post off** – sets XML/JSON HTTP Post off

Rights: Master

Syntax: `set post=off`

Example

Command: `set post=off`

Answer: `post=off,period=00:02:00`

- **MQTT on** – sets MQTT on

Rights: Master

Syntax: `set_mqtt=on`

Example

Command: `set mqtt=on`

Answer: `mqtt=on,mdata=json,period=00:05:00`

- **MQTT off** – sets MQTT off

Rights: Master

Syntax: `set_mqtt=off`

Example

Command: `set mqtt=off`

Answer: `mqtt=off,mdata=json,period=00:05:00`

- **MQTT period** – sets MQTT publish period

Rights: Master

Syntax: `set_mper=<time>`

Where

<time> is between 00:01:00 and 48:00:00 (hh:mm:ss)

Example

Command: set mper=00:05:00
Answer: mqtt=on,mdata=json,period=00:05:00

- **MQTT data** – sets MQTT data format

Rights: Master
Syntax: set_mdata=<format>
Where
<format> is “json” or “plain”

Example

Command: set mdata=plain
Answer: mqtt=on,mdata=plain,period=00:05:00

- **MQTT server** – sets MQTT server

Rights: Master
Syntax: set_murl=<link>
Where
<link> is the address of remote server (domain or IP)

Example

Command: set murl= www.teracomsystems.com
Answer: mqtt=on,murl= www.teracomsystems.com,port=1883

- **MQTT port** – sets MQTT port

Rights: Master
Syntax: set_mport=<port>
Where
<port> is a MQTT port

Example

Command: set mport= 8883
Answer: mqtt=on,murl= www.teracomsystems.com,port=8883

- **Set a time server**

Rights: Master
Syntax: set_ts=url:port

Example

Command: set ts=time.google.com:123
Answer: ts=time.google.com:123,tz=+02:00

- **Set a time zone**

Rights: Master
Syntax: set_tz=±hh:mm

Example

Command: set tz=+03:00
Answer: ts=time.google.com:123,tz=+03:00

- **Restart** – restarts the device

Rights: Master
Syntax: restart

Example

Command: restart
Answer: Device is restarting!

- **Send test email** – a message for sending a test email to the email users

Rights: Master
 Syntax: test_email

Example

Command: test email
Answer: Emails are sending!

- **Send test SMS** – a message for sending a test SMS to the authorized users

Rights: Master
 Syntax: test_sms

Example

Command: test sms
Answer: This is a test SMS!

- **Update** – a message for update the device over the air (needs LTE/WCDMA/GPRS)

Rights: Master
 Syntax: update_<URL>
 Where
 <URL> is a valid URL to public server, pointing update (.cod) file

Example

Command: update www.teracomsystems.com/docs/TCG140-4-v1.000-P-S.cod
Answer 1: Downloading firmware...
Answer 2: Firmware file downloaded. Updating...

Following answers are also possible in different situations:

Answer: File corrupt or wrong version!
Answer: Can't connect to server!
Answer: Download time out!
Answer: 4G/3G/2G is not connected!
Answer: Connection lost!
Answer: Response timeout!
Answer: Socket error!

- **Set Mobile network connection reset**

Rights: Master
 Syntax: set mncr=<status>,hh:mm:ss
 Where
 <status> - "on" or "off"

Example: enable mobile network connection reset and set time
Command: set mncr=on,10:00:00
Answer: mncr=on,10:00:00
Example: disable mobile network connection reset
Command: set mncr=off
Answer: mncr=off,10:00:00

- **Set a sensor notification delay**

Rights: Master
 Syntax: set delsen=xxxx

where
xxxx – notification delay in seconds (0-3600)

Example:

Command: `set delsen=5`

Answer: `delsen=5`

- **Set a sensor limits**

Rights: Master

Syntax: `set lspt=naaaa,xbbbb,ycccc`

where

p sensor number; valid values 1,2,3 or 4;

t parameter of the sensor; valid values 1 or 2;

n stands for "Min"

aaaa value for limit "Min";

x stands for "Max"

bbbb value for limit "Max"

y stands for "Hys"

cccc value for "Hys".

Example: *set of sensor 1 parameter 1 (temperature):*

Command: `set ls11=n25.0,x35.0,y1.0`

Answer: `ls11=n25.0,x35.0,y1.0`

Command: `set ls11=n31.0`

Answer: `ls11=n31.0,x35.0,y1.0`

Example: *set of sensor 1 parameter 2 (humidity):*

Command: `set ls12=n45.0,x60.0,y1.0`

Answer: `ls12=n45.0,x60.0,y1.0`

9. Protocols and API

9.1. HTTP API

HTTP is a very popular protocol for the implementation of remote monitoring and control SCADA systems. These systems are built on client-server technology.

TCG140-4 supports client mode – HTTP/HTTPS Post. This makes the device compatible with all SCADA software running HTTP protocol.

9.2. XML/JSON file HTTP Post

When this service is active, the module periodically sends the HTTP Post to a server. The Post contains an XML or JSON file with the current status of monitored parameters.

HTTP and HTTPS protocols are supported.

The Post can be sent also on an alarm condition - as an analogy of the SNMP trap.

On every HTTP Post, the server returns a response in accordance with the HTTP protocol. Only if "Process Answer" is enabled, TCG140-4 will execute the commands, contained in the answer. Otherwise, the device will terminate the connection immediately after the response.

A very important parameter in this communication is the HTTP Post period. With a shorter time period the device generates more data traffic, but this keeps the information and possibility to control the device closer to "real-time".

The HTTP Post period can be changed by the server with the appropriate HTTP command. This makes communication very flexible.

9.2.1. Commands

The commands for TCG140-4 are sent in the answer's body of HTTP Post request. The structure of command is:

set yyy=xxx

Where:

yyy is the command;

xxx is the parameter.

Example:

set r1=on – will turn on the relay 1.

set FIN – will terminate the session.

The full list of the commands is available on 9.4.

9.2.2. Typical communication session

Below is a typical communication session between TCG140-4 and a remote server, with "Process Answer" enabled:

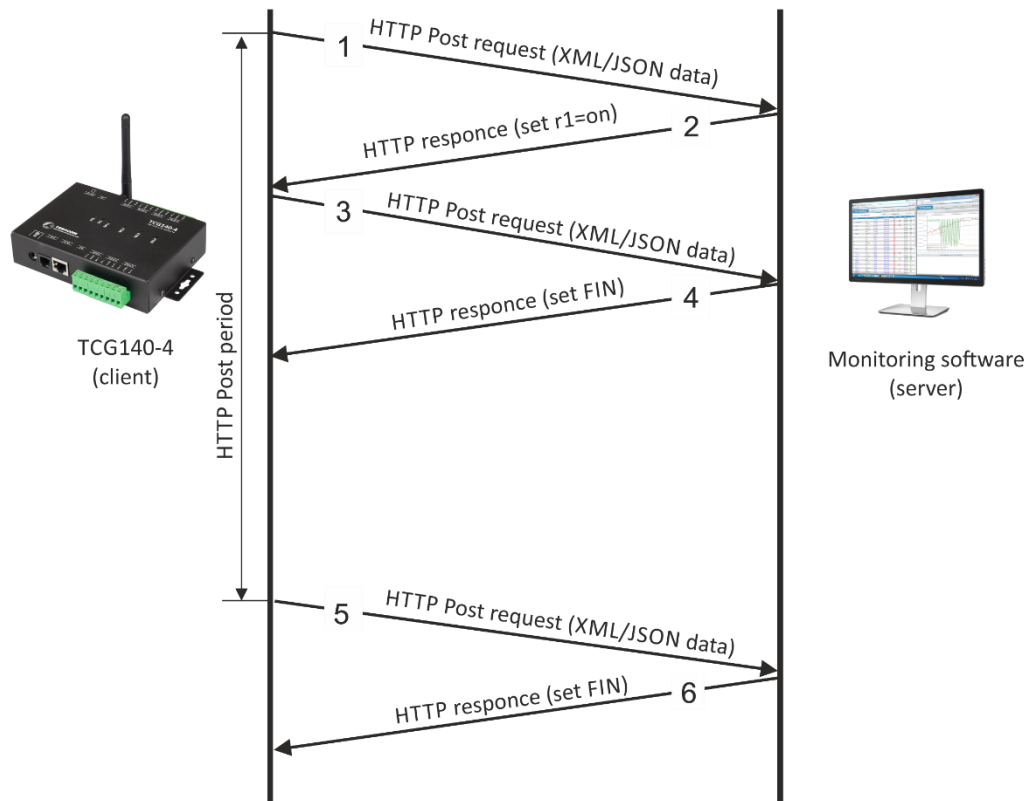

- The device sends HTTP Post request (1) with XML/JSON data to the remote server either on Post period or on alarm condition;
- The server returns HTTP response (2), which contains "set r1=on" command as a brief text in the message body;
- The device sends a new HTTP Post request (3) with updated XML/JSON data, which confirms the execution of "set r1=on" command;

- The server returns a new HTTP response (4), which includes “set FIN” in the message body. This indicates that there are no pending commands and the session can be closed;
- On next HTTP Post period, TCG140-4 sends a new HTTP Post request (5) to the server;
- The server answers with “set FIN” (6) – there are no pending commands and the session can be closed.

A typical monitoring application is shown below:

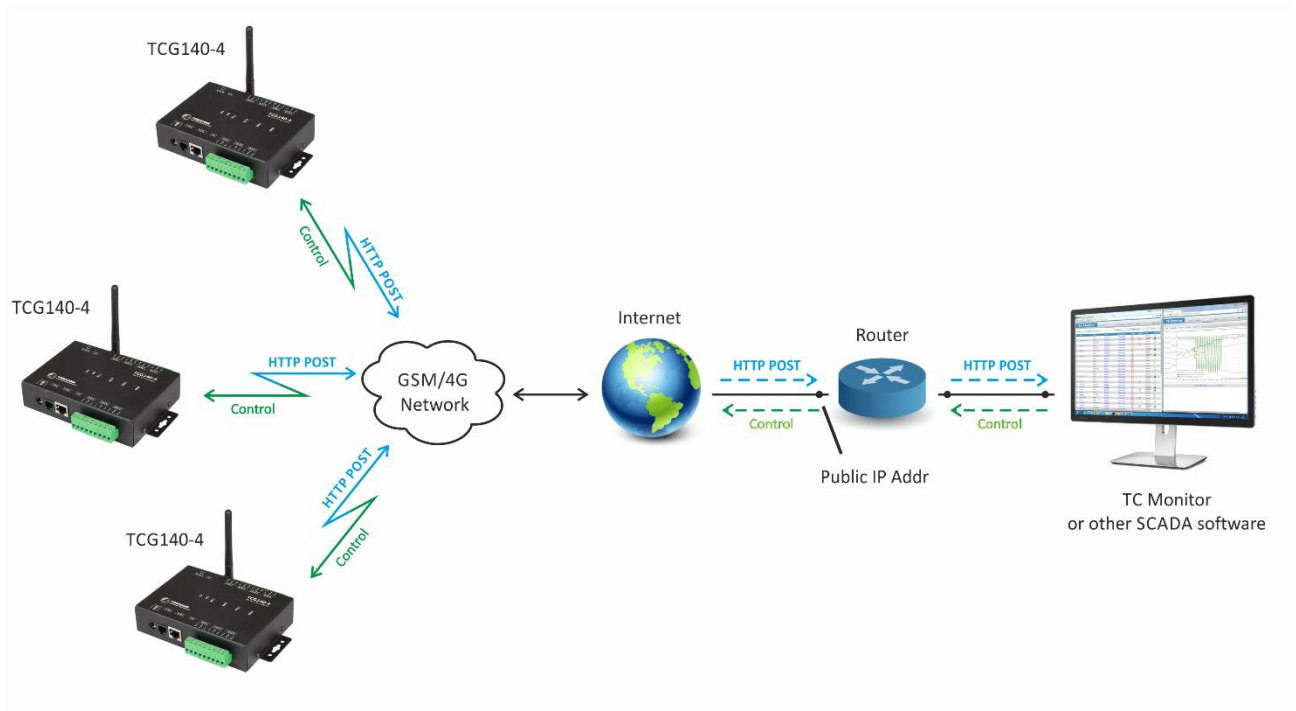

XML/JASON HTTP Post service can be tested following the steps below:

- Save following code like post.php:

```
<?php
define("FILENAME", 'status.xml');
define("FOLDER", "");
define("SEPARATOR", "");
define("STR_SUCCESS", 'set FIN');
define("STR_ERROR", 'error');

if($_SERVER['REQUEST_METHOD'] == 'POST'){
    $datePrefix = date('YmdHis', strtotime('now'));
    $pathname = FOLDER.SEPARATOR.$datePrefix.'_' .FILENAME;
    $postdata = file_get_contents("php://input");
    $handle = fopen($pathname, 'w+');
    $content = var_export($postdata, true);
    fwrite($handle, substr($content, 1, strlen($content)-2));
    fclose($handle);
    echo (($handle === false) ? STR_ERROR : STR_SUCCESS)."\r\n";
}
else {
    echo "The PHP script is working!";
}
?>
```

- Copy the *post.php* file on a WEB server with PHP support. The server should have visibility from the Internet. The UniServer and XAMP are the most popular WEB servers for Windows.

- To verify that the script is working properly, type the URL (for example www.yourserverURL.com/post.php) in the WEB browser. If all is OK, a WEB page with “The PHP script is working!” will be shown.
- Activate XML/JSON HTTP Post service to www.yourserverURL.com/post.php.
- Click on the “Test HTTP Post” button.
- If the HTTP Post is received and processed, “OK” will be shown close to the button. Along with this, an XML/JSON file will be created in the same directory, where *post.php* is located. The file name will contain time information. For example - 20210601103318_status.xml.

9.3. List of HTTP API commands

TCG140-4 supports following HTTP commands (case sensitive):

| Command | Description |
|-------------|-----------------------------------------------------------------------------------------------------------------------------------------------------------------------------------------------------------------------------------------------------------------------------------------|
| rn=xxx | Turn relay n ON (xxx=on) or OFF (xxx=off) (n is 1,2,3 or 4 for the respective relay) r2=on – will turn relay 2 ON r4=off – will turn relay 4 OFF r1=on&r2=on&r3=on&r4=on – will turn all relays ON r1=off&r2=off&r3=off&r4=off – will turn all relays OFF |
| rn=tg | Toggle relay n (n is 1,2,3 or 4 for the respective relay) r2= tg – will toggle relay 2 r1=tg&r4=tg – will toggle relay 1 and 4 |
| rn=pl | Pulse relay n (n is 1,2,3 or 4 for the respective relay) r3=pl – will pulse relay 3 r1=pl&r2=pl&r3=pl&r4=pl |
| vnf=10.0 | Set Min of analog input to 10.0 (f is 1,2,3 or 4 for the respective input) vn1=10.0 will set Min for analog input 1 |
| vxf=20.0 | Set Max of analog input to 20.0 (f is 1,2,3 or 4 for the respective input) vx2=20.0 will set Max for analog input 2 |
| vyf=1.0 | Set Hys of analog input to 1.0 (f is 1,2,3 or 4 for the respective input) vy4=1.0 will set Hys for analog input 4 |
| snpt=30.0 | Set Min of sensor to 30.0 (p is 1,2,3,4,5,6,7 or 8 for the respective sensor t is 1 or 2 for the respective parameter of sensor) sn12=30.0 will set Min for sensor 1, parameter 2 |
| sxpt=40.0 | Set Max of sensor to 40.0 (p is 1,2,3,4,5,6,7 or 8 for the respective sensor t is 1 or 2 for the respective parameter of sensor) sx42=40.0 will set Min for sensor 4, parameter 2 |
| sypt=2.0 | Set Hys of sensor to 2.0 (p is 1,2,3,4,5,6,7 or 8 for the respective sensor t is 1 or 2 for the respective parameter of sensor) sy81=2.0 will set Hys for sensor 8, parameter 1 |
| delsen=xxxx | Notification delay for sensors (xxxx is between 0 and 3600) |
| delanl=xxxx | Notification delay for analog inputs (xxxx is between 0 and 3600) |

| | |
|-------------|---------------------------------------------------------------------------------------------------------------------------------------------------------------------------------------------------------------------------------------------------|
| deldig=xxxx | Notification delay for digital inputs (xxxx is between 0 and 3600) |
| dda1=xxxx | Low to high delay for digital input 1 (xxxx is between 0 and 3600) |
| ddd1=xxxx | High to low delay for digital input 1 (xxxx is between 0 and 3600) |
| dda2=xxxx | Low to high delay for digital input 2 (xxxx is between 0 and 3600) |
| ddd2=xxxx | High to low delay for digital input 2 (xxxx is between 0 and 3600) |
| dataf=x | Data format XML/JSON for HTTP Post – 0 XML, 1 JSON |
| purl=yyy | URL for XML/JSON HTTP Post to Server 1, where yyy is a full path to php file purl=212.25.45.120:30181/xampp/test/pushtest.php |
| purl2=yyy | URL for XML/JSON HTTP Post to Server 2, where yyy is a full path to php file purl=212.25.45.120:30181/xampp/test/pushtest.php |
| pper=x | XML/JSON HTTP Post period in seconds (x is between 60 and 172800) pper=600 – will set Post period to 600 seconds |
| dk=xxx | XML/JSON HTTP Post key – xxx is up to 17 characters |
| mdata=x | Data format JSON/Plain text for MQTT Publish – 0 JSON, 1 Plain text |
| mmode=x | Publish protocol, where x is 0 for unsecure and 1 for TLS/SSL |
| muser=xxxx | Username authentication for MQTT, where xxxx is a username |
| mpass=xxxx | Password authentication for MQTT, where xxxx is a password |
| murl=yyy | URL for MQTT publish, where yyy is a path murl=212.25.45.120 |
| mport=yyyy | Port for MQTT publish, where yyyy is a port mport=1883 |
| mper=x | MQTT publish period in seconds (x is between 60 and 172800) mper=600 – will set MQTT publish period to 600 seconds |
| save | Save all previous changes (except relays' one) in the FLASH memory. As every save reflects the FLASH cycles (endurance), this command should be used very carefully. pper=120&save – will set Post period to 120 seconds and save it |
| FIN | Terminate the session |

Multiply commands are sent concatenated with “&”.

The commands are sent in the answer on XML/JSON or CSV HTTP Posts. They are executed if “Process Answer” is enabled.

9.4. File structures

For XML file structure please see Appendix A.

For JSON file structure please see Appendix B.

9.5. MODBUS RTU

9.5.1. Communication parameters

For MODBUS RTU, TCG140-4 supports the following communication parameters:

- Baud rate – 2400, 4800, 9600, 19200, 38400, or 57600;
- Data bits – 8;
- Stop bits – 1 or 2;
- Parity – Odd or Even;

As factory default communication parameters, the device uses standard ones for MODBUS RTU:

- Baud rate – 19200;
- Data bits – 8;
- Stop bits – 1;
- Parity – Even;

9.5.2. Teracom sensors update tool

TCG140-4 supports sensor FW update tool.

The tool is available at <http://device.ip.address/teracom485.htm>.

Attention! To make any changes to the MODBUS RTU sensor it should be alone on the RS-485 bus.

9.5.2.1 Sensor settings

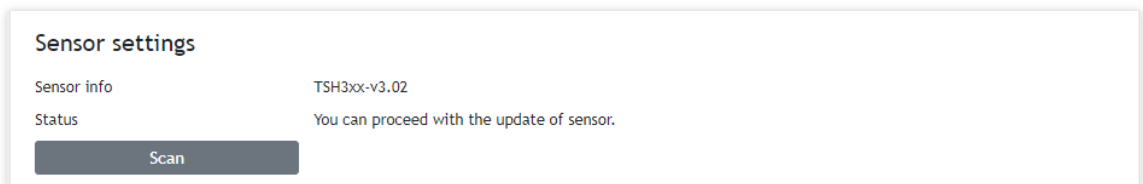

The screenshot shows a web interface titled "Sensor settings". It contains two rows of information: "Sensor info" with the value "TSH3xx-v3.02" and "Status" with the message "You can proceed with the update of sensor.". Below this information is a dark grey button labeled "Scan".

The tool works with the current MODBUS RTU communication parameters.

To avoid collisions the good practice is to set TCG140-4 and the sensor with the factory default MODBUS RTU communication parameters. This will ensure a smooth operation. The default MODBUS RTU communication parameters for TCG140-4 are described in 8.5.1. Communication parameters.

Before making any changes, it is strongly recommended to scan for sensor settings. This will inform about the current FW version of the sensor but also will check if the sensor is alone on the bus.

9.5.2.2 Sensor FW update

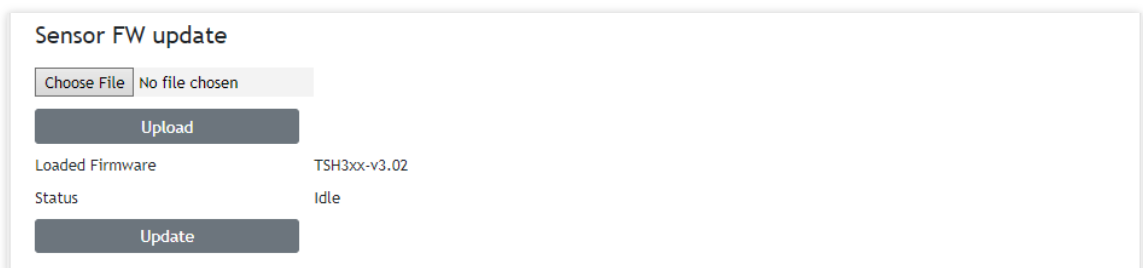

The screenshot shows a web interface titled "Sensor FW update". It features a file selection area with a "Choose File" button and the text "No file chosen". Below this is a dark grey "Upload" button. Further down, it displays "Loaded Firmware" as "TSH3xx-v3.02" and "Status" as "Idle". At the bottom, there is a dark grey "Update" button.

To arrange the FW update, the appropriate file should be uploaded to the sensor first and after this, the button "Update" should be pressed.

9.6. MQTT

MQTT is a Client-Server publish/subscribe messaging transport protocol. It is lightweight, open, simple, and designed so as to be easy to implement. MQTT is used in a wide variety of industries, such as automotive, manufacturing, telecommunications, oil, gas and etc.

More about MQTT can be read at www.mqtt.org.

10. Data Logger

The logger utilizes a circular buffer in FLASH memory. When the logger makes a full scroll of the circular buffer, the new data overwrites the oldest one. In this manner FLASH memory stores the full log all the time. A copy of the full log is available for download.

The number of records depends on the length of descriptions and what kind of characters are used. In the worst case (15 bytes description with characters from the highest part of UTF-8) the number of records is about 37000. This number is enough for 25 days with records on every 1 minute.

In most cases, the data logger can keep 53000 records, which is enough for 36 days with records on every 1 minute.

The new records can be periodically uploaded as SCV file to a dedicated HTTP server in – 1, 2, 3, 4, 6, 8, 12, or 24 hours. A semicolon is used as a delimiter.

The first row of the log file is always the header. All rows, including the header, start with a record ID and time stamp.

The structure of one row (a record) of the log is as follows:

| ID | Time | Type of record | Inputs value | Relays | Alarm conditions |
|----|------|----------------|--------------|--------|------------------|
|----|------|----------------|--------------|--------|------------------|

| | |
|------------------|---------------------------------------------------------------------------------------------------------------------------------------------------------------------------------------------------------------------------------------------------------------------------------------------------------------------|
| ID | 32-bit unique number for every row (record). |
| Time | a time stamp of record, in format yyyy.mm.dd, hh:mm:ss. |
| Type of record | following types of records are available: "Time" for periodical record; "Event" for record initiated by alarm condition; "Type" for header record; "Start" after power-up condition; "Restart" after reset condition; "Power Down" after power-down condition; "Bad" for a problematic record. |
| Inputs value | in orders – sensors, analog inputs and digital inputs. |
| Relays | the relays conditions. |
| Alarm conditions | show conditions for every input, "1" means an active alarm. |

An example of the log file:

```
1131901;06.01.2021,01:02:23;Type;S11/°C;S12;S21/°C;S22;S31/°C;S32;S41/°C;S42;S51/°C;S52;S61/°C;S62;S71/°C;S72;S81/°C;S82;A1/V;A2/V;D1;D2;R1;R2;S1
1/°C;S12;S21/°C;S22;S31/°C;S32;S41/°C;S42;S51/°C;S52;S61/°C;S62;S71/°C;S72;S81/°C;S82;A1/V;A2/V;D1;D2;
1131902; 06.01.2021,01:02:23;Time;18.250;;18.375;;18.125;;18.500;;18.188;;18.125;;18.375;;18.375;;11.352;0.065;1;0;1;0;1;1;1;1;1;1;1;1;1;1;1;0;1;0;
1131903; 06.01.2021,01:02:23;Event;18.250;;18.438;;18.125;;18.500;;18.188;;18.125;;18.313;;18.375;;11.352;0.066;0;1;0;1;1;1;1;1;1;1;1;1;1;1;1;0;0;1;
1131904; 06.01.2021,01:02:24;Time;18.250;;18.438;;18.125;;18.500;;18.188;;18.125;;18.313;;18.375;;11.352;0.066;0;1;0;1;1;1;1;1;1;1;1;1;1;1;1;0;0;1;
1131905; 06.01.2021,01:02:25;Time;18.250;;18.375;;18.125;;18.500;;18.188;;18.125;;18.313;;18.375;;11.352;0.066;0;1;0;1;1;1;1;1;1;1;1;1;1;1;1;0;0;1;
1131906; 06.01.2021,01:02:26;Time;18.250;;18.375;;18.125;;18.500;;18.188;;18.125;;18.313;;18.313;;11.352;0.066;0;1;0;1;1;1;1;1;1;1;1;1;1;1;1;1;0;0;1;
1131907; 06.01.2021,01:02:27;Time;18.250;;18.375;;18.125;;18.438;;18.188;;18.125;;18.313;;18.313;;11.352;0.066;0;1;0;1;1;1;1;1;1;1;1;1;1;1;1;1;0;0;1;
1131908; 06.01.2021,01:02:27;Event;18.250;;18.375;;18.125;;18.438;;18.188;;18.125;;18.313;;18.313;;2.198;9.092;0;1;0;1;1;1;1;1;1;1;1;1;1;1;1;1;0;0;0;1;
```

11. Firmware update

TCG140-4 supports firmware update over the WEB interface and over the air.

For firmware update over the WEB interface please see 7.4.2. FW update.

For firmware update over the air (needs 4GLTE/3G/2G connection) please follow the steps below:

- Upload the update file (.cod extension) on public HTTP server ;
- Send firmware update command (the syntax of the SMS message is described in 8. Setup via SMS).

Attention! Only the Master can send this message.

The firmware will be downloaded and verified. The download takes about 3 minutes. If the file is correct, the Master will receive a confirmation SMS message. The update procedure takes about 2 minutes. Once the firmware update is complete (about 5 minutes), TCG140-4 will restart.

Attention! Don't turn off the power supply during the update. Turning off the power supply will damage the device.

12. Factory default settings

TCG140-4 can be restored to its factory default settings by the following steps:

- Turn off the power supply;
- Press and hold the RESET button then turn on the power supply;
- STA and SIG LEDs will turn ON;
- Release the RESET button.

The module will restore its default settings.



13. Environment information

This equipment is intended for use in a Pollution Degree 2 environment, at altitudes up to 2000 meters. When the module is a part of a system, the other elements of the system shall comply with the EMC requirements and shall be intended for use in the same ambient conditions.

14. Safety

This device must not be used for medical, life-saving purposes or for any purpose where its failure could cause serious injury or the loss of life.



This product contains a coin/button cell battery. Do not ingest battery, Chemical Burn Hazard.

If the coin/button cell battery is swallowed, it can cause severe internal burns in just 2 hours and can lead to death.

Keep new and used batteries away from children.

If the battery compartment does not close securely, stop using the product and keep it away from children.

If you think batteries might have been swallowed or placed inside any part of the body, seek immediate medical attention.



To reduce the risk of fire, only flexible stranded wire, with cross-section 0.5mm² or larger for wiring of digital and analog inputs and relay output of the device should be used.

To avoid electric shock and fire hazards, do not expose this product to liquids, rain, or moisture. Objects filled with liquids, such as vases, should not be placed on this device.

There is a risk of overheating (damage) of the module, if recommended free spaces to adjacent devices are not ensured. Joint part with external component shall have space for attachment/removal of the cable after installation.

Teracom does not guarantee a successful operation of the product if the product was used under conditions deviating from the product specifications.

15. Maintenance

Upon completion of any service or repairs to the device or once per year, a safety check must be performed to determine that this product is in proper operating condition. Clean the device only with a dry cloth. Do not use a liquid cleaner or an aerosol cleaner. Do not use a magnetic/static cleaning device (dust remover) or any kind of abrasive materials to clean the device.

16. Package content

The box contains:

- TCG140-4
- Multi-band antenna - 698 to 960 and 1710 to 2690MHz
- Four spacers/bumpers
- RS-485 terminator
- Quick start guide

The XML file (status.xml) structure:

```

<Monitor>
  <DeviceInfo>
    <DeviceName>TCG140-4</DeviceName>
    <HostName>TCG140-4</HostName>
    <ID>862632040544279</ID>
    <FwVer>TCG140-4-v1.000</FwVer>
    <MnfInfo>www.teracomsystems.com</MnfInfo>
    <SysContact>info@teracomsystems.com</SysContact>
    <SysName>TCG140-4</SysName>
    <SysLocation>Location</SysLocation>
  </DeviceInfo>
  <S>
    <S1>
      <description>S1:TST1xx</description>
      <id>2867895F07000058</id>
      <type>1W</type>
      <addr>1Wire</addr>
      <item1>
        <value>24.2</value>
        <unit>°C</unit>
        <alarm>0</alarm>
        <min>19.0</min>
        <max>100.0</max>
        <hys>0.5</hys>
      </item1>
      <item2>
        <value>---</value>
        <unit>---</unit>
        <alarm>0</alarm>
        <min>---</min>
        <max>---</max>
        <hys>---</hys>
      </item2>
    </S1>
    <S2>
      <description>S2</description>
      <id>0000000000000000</id>
      <type>1W</type>
      <addr>1Wire</addr>
      <item1>
        <value>---</value>
        <unit>---</unit>
        <alarm>0</alarm>
        <min>---</min>
        <max>---</max>
        <hys>---</hys>
      </item1>
      <item2>
        <value>---</value>
        <unit>---</unit>
        <alarm>0</alarm>
        <min>---</min>
        <max>---</max>
        <hys>---</hys>
      </item2>
    </S2>
    <S3>
      <description>S3</description>
      <id>0000000000000000</id>
      <type>1W</type>
      <addr>1Wire</addr>
      <item1>
        <value>---</value>
        <unit>---</unit>

```

```

        <alarm>0</alarm>
        <min>---</min>
        <max>---</max>
        <hys>---</hys>
    </item1>
    <item2>
        <value>---</value>
        <unit>---</unit>
        <alarm>0</alarm>
        <min>---</min>
        <max>---</max>
        <hys>---</hys>
    </item2>
</S3>
<S4>
    <description>S4</description>
    <id>0000000000000000</id>
    <type>1W</type>
    <addr>1Wire</addr>
    <item1>
        <value>---</value>
        <unit>---</unit>
        <alarm>0</alarm>
        <min>---</min>
        <max>---</max>
        <hys>---</hys>
    </item1>
    <item2>
        <value>---</value>
        <unit>---</unit>
        <alarm>0</alarm>
        <min>---</min>
        <max>---</max>
        <hys>---</hys>
    </item2>
</S4>
<S5>
    <description>S5</description>
    <id>3300000000000000</id>
    <type>MB</type>
    <addr>3</addr>
    <item1>
        <value>25.0</value>
        <unit>°C</unit>
        <alarm>0</alarm>
        <min>-40.0</min>
        <max>85.0</max>
        <hys>8.5</hys>
    </item1>
    <item2>
        <value>34.8</value>
        <unit>%RH</unit>
        <alarm>0</alarm>
        <min>0.0</min>
        <max>100.0</max>
        <hys>10.0</hys>
    </item2>
</S5>
<S6>
    <description>S6</description>
    <id>0000000000000000</id>
    <type>MB</type>
    <addr>0</addr>
    <item1>
        <value>---</value>
        <unit>---</unit>
        <alarm>0</alarm>
        <min>---</min>

```



```

        <max>---</max>
        <hys>---</hys>
    </item1>
    <item2>
        <value>---</value>
        <unit>---</unit>
        <alarm>0</alarm>
        <min>---</min>
        <max>---</max>
        <hys>---</hys>
    </item2>
</S6>
<S7>
    <description>S7</description>
    <id>0000000000000000</id>
    <type>MB</type>
    <addr>0</addr>
    <item1>
        <value>---</value>
        <unit>---</unit>
        <alarm>0</alarm>
        <min>---</min>
        <max>---</max>
        <hys>---</hys>
    </item1>
    <item2>
        <value>---</value>
        <unit>---</unit>
        <alarm>0</alarm>
        <min>---</min>
        <max>---</max>
        <hys>---</hys>
    </item2>
</S7>
<S8>
    <description>S8</description>
    <id>0000000000000000</id>
    <type>MB</type>
    <addr>0</addr>
    <item1>
        <value>---</value>
        <unit>---</unit>
        <alarm>0</alarm>
        <min>---</min>
        <max>---</max>
        <hys>---</hys>
    </item1>
    <item2>
        <value>---</value>
        <unit>---</unit>
        <alarm>0</alarm>
        <min>---</min>
        <max>---</max>
        <hys>---</hys>
    </item2>
</S8>
</S>
<AI>
    <AI1>
        <description>Analog Input 1</description>
        <value>0.000</value>
        <unit>V</unit>
        <multiplier>1.000</multiplier>
        <offset>0.0000</offset>
        <alarm>0</alarm>
        <min>0.000</min>
        <max>10.000</max>
        <hys>1.000</hys>
    </AI1>

```

```

</AI1>
<AI2>
  <description>Analog Input 2</description>
  <value>0.000</value>
  <unit>V</unit>
  <multiplier>1.000</multiplier>
  <offset>0.0000</offset>
  <alarm>0</alarm>
  <min>0.000</min>
  <max>10.000</max>
  <hys>1.000</hys>
</AI2>
<AI3>
  <description>Analog Input 3</description>
  <value>0.000</value>
  <unit>V</unit>
  <multiplier>1.000</multiplier>
  <offset>0.0000</offset>
  <alarm>0</alarm>
  <min>0.000</min>
  <max>10.000</max>
  <hys>1.000</hys>
</AI3>
<AI4>
  <description>Analog Input 4</description>
  <value>0.000</value>
  <unit>V</unit>
  <multiplier>1.000</multiplier>
  <offset>0.0000</offset>
  <alarm>0</alarm>
  <min>0.000</min>
  <max>10.000</max>
  <hys>1.000</hys>
</AI4>
</AI>
<DI>
  <DI1>
    <description>Digital Input 1</description>
    <value>OPEN</value>
    <valuebin>1</valuebin>
    <alarmState>CLOSED</alarmState>
    <alarm>0</alarm>
  </DI1>
  <DI2>
    <description>Digital Input 2</description>
    <value>OPEN</value>
    <valuebin>1</valuebin>
    <alarmState>CLOSED</alarmState>
    <alarm>0</alarm>
  </DI2>
</DI>
<R>
  <R1>
    <description>Relay 1</description>
    <value>OFF</value>
    <valuebin>0</valuebin>
    <pulseWidth>0.1</pulseWidth>
    <control>0</control>
  </R1>
  <R2>
    <description>Relay 2</description>
    <value>OFF</value>
    <valuebin>0</valuebin>
    <pulseWidth>0.2</pulseWidth>
    <control>0</control>
  </R2>
  <R3>
    <description>Relay 3</description>

```

```

    <value>OFF</value>
    <valuebin>0</valuebin>
    <pulseWidth>0.3</pulseWidth>
    <control>0</control>
</R3>
<R4>
  <description>Relay 4</description>
  <value>OFF</value>
  <valuebin>0</valuebin>
  <pulseWidth>0.4</pulseWidth>
  <control>0</control>
</R4>
</R>
<HTTPPush>
  <Key/>
  <PushPeriod>300</PushPeriod>
</HTTPPush>
<MQTT>
  <Period>300</Period>
</MQTT>
<signalpercent>67</signalpercent>
<hwerr></hwerr>
<Alarmed>0</Alarmed>
<Scannig>Scan</Scannig>
<Time>
  <Date>16.02.2021</Date>
  <Time>14:19:12</Time>
</Time>
<NetworkInfo>
  <Name>A1 BG A1 BG</Name>
  <SC>
    <MCC>284</MCC>
    <MNC>01</MNC>
    <LAC>28201</LAC>
    <CID>46743</CID>
    <SQ>-71</SQ>
  </SC>
</NetworkInfo>
</Monitor>

```

Where:

*<value>--- </value> and <unit>--- </unit> means no 1-Wire sensor on this position;
 <alarm>1</alarm> means there is a trigger condition.*

The JSON file (status.json)structure:

```
{
  "Monitor": {
    "DeviceInfo": {
      "DeviceName": "TCG140-4",
      "HostName": "TCG140-4",
      "ID": "862632040544279",
      "FwVer": "TCG140-4-v1.000",
      "MnflInfo": "www.teracomsystems.com",
      "SysContact": "info@teracomsystems.com",
      "SysName": "TCG140-4",
      "SysLocation": "Location"
    },
    "S": {
      "S1": {
        "description": "S1:TST1xx",
        "id": "2867895F07000058",
        "type": "1W",
        "addr": "1Wire",
        "item1": {
          "value": "24.0",
          "unit": "°C",
          "alarm": "0",
          "min": "19.0",
          "max": "100.0",
          "hys": "0.5"
        },
        "item2": {
          "value": "---",
          "unit": "---",
          "alarm": "0",
          "min": "---",
          "max": "---",
          "hys": "---"
        }
      },
      "S2": {
        "description": "S2",
        "id": "0000000000000000",
        "type": "1W",
        "addr": "1Wire",
        "item1": {
          "value": "---",
          "unit": "---",
          "alarm": "0",
          "min": "---",
          "max": "---",
          "hys": "---"
        },
        "item2": {
          "value": "---",
          "unit": "---",
          "alarm": "0",
          "min": "---",
          "max": "---",
          "hys": "---"
        }
      },
      "S3": {
        "description": "S3",
        "id": "0000000000000000",
        "type": "1W",
        "addr": "1Wire",
        "item1": {
          "value": "---",

```

```

        "unit": "---",
        "alarm": "0",
        "min": "---",
        "max": "---",
        "hys": "---"
    },
    "item2": {
        "value": "---",
        "unit": "---",
        "alarm": "0",
        "min": "---",
        "max": "---",
        "hys": "---"
    }
},
"S4": {
    "description": "S4",
    "id": "0000000000000000",
    "type": "1W",
    "addr": "1Wire",
    "item1": {
        "value": "---",
        "unit": "---",
        "alarm": "0",
        "min": "---",
        "max": "---",
        "hys": "---"
    },
    "item2": {
        "value": "---",
        "unit": "---",
        "alarm": "0",
        "min": "---",
        "max": "---",
        "hys": "---"
    }
},
"S5": {
    "description": "S5",
    "id": "3300000000000000",
    "type": "MB",
    "addr": "3",
    "item1": {
        "value": "25.1",
        "unit": "°C",
        "alarm": "0",
        "min": "-40.0",
        "max": "85.0",
        "hys": "8.5"
    },
    "item2": {
        "value": "34.6",
        "unit": "%RH",
        "alarm": "0",
        "min": "0.0",
        "max": "100.0",
        "hys": "10.0"
    }
},
"S6": {
    "description": "S6",
    "id": "0000000000000000",
    "type": "MB",
    "addr": "0",
    "item1": {
        "value": "---",
        "unit": "---",
        "alarm": "0",

```

```

    "min": "---",
    "max": "---",
    "hys": "----"
  },
  "item2": {
    "value": "---",
    "unit": "---",
    "alarm": "0",
    "min": "---",
    "max": "---",
    "hys": "----"
  }
},
"S7": {
  "description": "S7",
  "id": "0000000000000000",
  "type": "MB",
  "addr": "0",
  "item1": {
    "value": "---",
    "unit": "---",
    "alarm": "0",
    "min": "---",
    "max": "---",
    "hys": "----"
  },
  "item2": {
    "value": "---",
    "unit": "---",
    "alarm": "0",
    "min": "---",
    "max": "---",
    "hys": "----"
  }
},
"S8": {
  "description": "S8",
  "id": "0000000000000000",
  "type": "MB",
  "addr": "0",
  "item1": {
    "value": "---",
    "unit": "---",
    "alarm": "0",
    "min": "---",
    "max": "---",
    "hys": "----"
  },
  "item2": {
    "value": "---",
    "unit": "---",
    "alarm": "0",
    "min": "---",
    "max": "---",
    "hys": "----"
  }
},
"AI": {
  "AI1": {
    "description": "Analog Input 1",
    "value": "0.000",
    "unit": "V",
    "multiplier": "1.000",
    "offset": "0.0000",
    "alarm": "0",
    "min": "0.000",
    "max": "2.000",

```

```

    "hys": "0.010"
  },
  "AI2": {
    "description": "Analog Input 2",
    "value": "0.000",
    "unit": "V",
    "multiplier": "1.000",
    "offset": "0.0000",
    "alarm": "0",
    "min": "0.000",
    "max": "2.000",
    "hys": "0.010"
  },
  "AI3": {
    "description": "Analog Input 3",
    "value": "0.000",
    "unit": "V",
    "multiplier": "1.000",
    "offset": "0.0000",
    "alarm": "0",
    "min": "0.000",
    "max": "2.000",
    "hys": "0.010"
  },
  "AI4": {
    "description": "Analog Input 4",
    "value": "0.000",
    "unit": "V",
    "multiplier": "1.000",
    "offset": "0.0000",
    "alarm": "0",
    "min": "0.000",
    "max": "10.000",
    "hys": "1.000"
  }
},
"DI": {
  "DI1": {
    "description": "Digital Input 1",
    "value": "OPEN",
    "valuebin": "1",
    "alarmState": "CLOSED",
    "alarm": "0"
  },
  "DI2": {
    "description": "Digital Input 2",
    "value": "OPEN",
    "valuebin": "1",
    "alarmState": "CLOSED",
    "alarm": "0"
  }
},
"R": {
  "R1": {
    "description": "Relay 1",
    "value": "OFF",
    "valuebin": "0",
    "pulseWidth": "0.1",
    "control": "0"
  },
  "R2": {
    "description": "Relay 2",
    "value": "OFF",
    "valuebin": "0",
    "pulseWidth": "0.2",
    "control": "0"
  },
  "R3": {

```

```

    "description": "Relay 3",
    "value": "OFF",
    "valuebin": "0",
    "pulseWidth": "0.3",
    "control": "0"
  },
  "R4": {
    "description": "Relay 4",
    "value": "OFF",
    "valuebin": "0",
    "pulseWidth": "0.4",
    "control": "0"
  }
},
"HTTPPush": {
  "Key": "",
  "PushPeriod": "300"
},
"MQTT": {
  "Period": "300"
},
"signalpercent": "67",
"hwerr": "",
"Alarmed": "0",
"Scannig": "Scan",
"Time": {
  "Date": "16.02.2021",
  "Time": "14:39:55"
},
"NetworkInfo": {
  "Name": "A1 BG A1 BG",
  "SC": {
    "MCC": "284",
    "MNC": "01",
    "LAC": "28201",
    "CID": "46596",
    "SQ": "-71"
  }
}
}
}
}

```

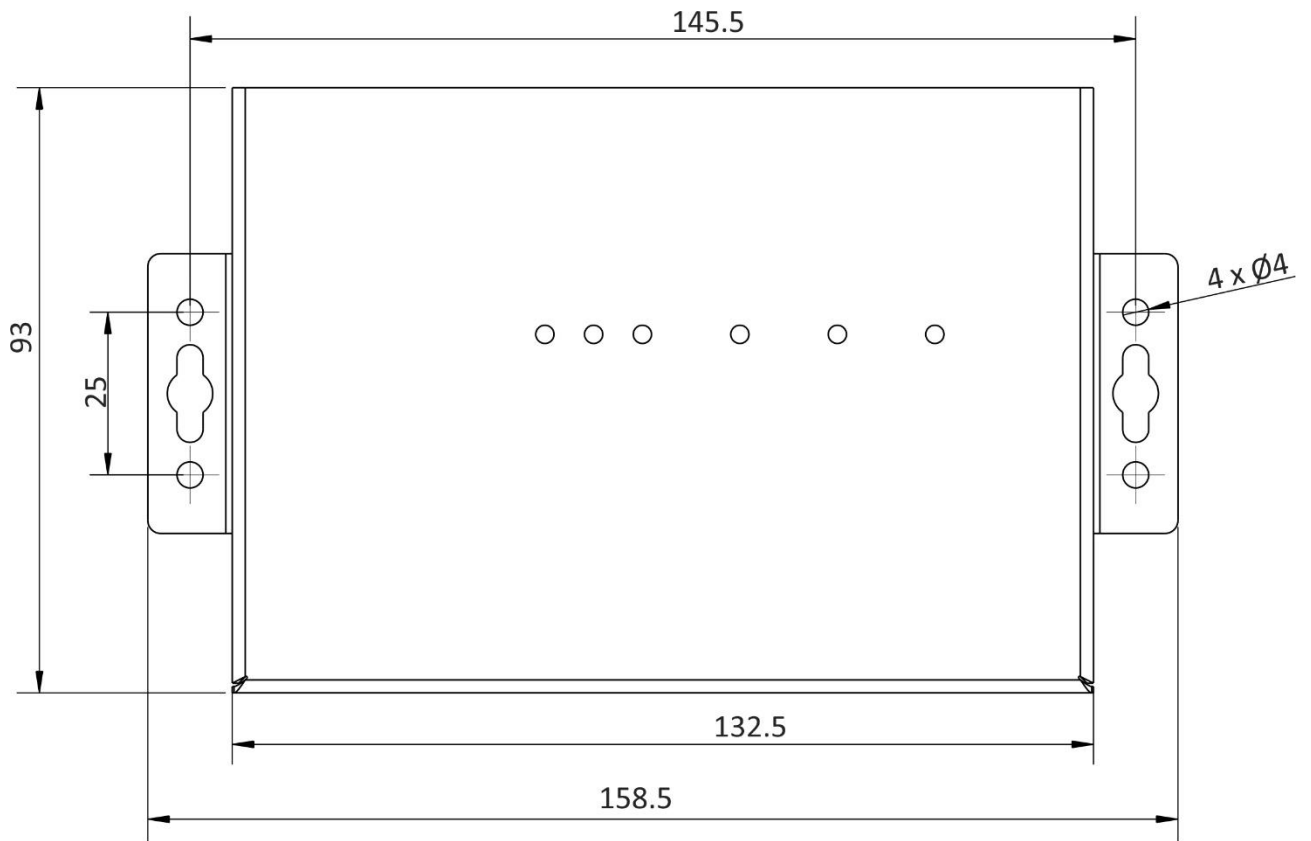



Fig.1

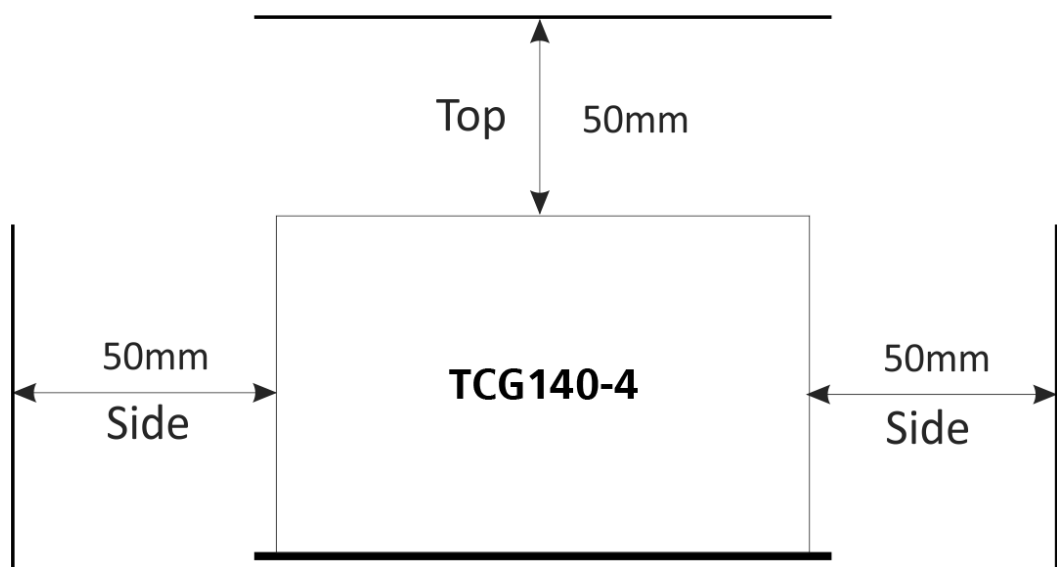

Fig.2