

# **PU1000/PU600 Installation manual**



## Warranty

All Polyamp DC/DC converters are warranted against defective material and workmanship. This warranty is valid for 5 years from the date of delivery. We will repair or replace products which prove to be defective during the warranty period. The warranty is valid only if the converter is used within specification.

## Manual

This manual is as complete and actual as possible at the time of printing. However, the information may have been updated since then. Polyamp AB reserves the right to make changes in this manual without notice.



The exclamation point within an equilateral triangle is intended to alert the user to presence of important operating and maintenance instructions in the literature accompanying

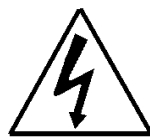

The lightning flash with arrowhead, within an equilateral triangle, is intended to alert the user to presence of uninsulated "dangerous voltage" within the products enclosure that may be of sufficient magnitude to constitute a risk of electric shock to persons

### Caution!

To prevent the risk of electric shock, do not open enclosure. No serviceable parts inside. Refer servicing to qualified service personnel only

## CONTENTS

<b>1 BEFORE INSTALLATION.....</b>	<b>4</b>
<b>2 INSTALLATION.....</b>	<b>4</b>
<b>3 PARALLEL CONNECTION .....</b>	<b>5</b>
3.1 SERIES DIODE ON THE OUTPUT.....	5
3.2 CURRENT SHARING.....	5
3.3 VOLTAGE ADJUSTMENT WITH CURRENT SHARING .....	6
<b>4 MULTIPLE LOADS AT THE OUTPUT .....</b>	<b>6</b>
4.1 SHORT-CIRCUITS .....	6
<b>5 ALARM .....</b>	<b>7</b>
5.1 OVER AND UNDER VOLTAGE ALARM .....	7
5.2 OVER TEMPERATURE.....	7
<b>6 SENSE.....</b>	<b>7</b>
6.1 EXTERNAL SENSE .....	7
6.2 INTERNAL SENSE .....	8
<b>7 INHIBIT .....</b>	<b>8</b>
<b>8 OUTPUT OVER VOLTAGE PROTECTION.....</b>	<b>8</b>
<b>9 INRUSH CURRENT LIMIT .....</b>	<b>8</b>
<b>10 ISOLATION VOLTAGE TEST.....</b>	<b>8</b>
10.1 DC ISOLATION TEST OUTPUT TO CASE .....	8
10.2 DC ISOLATION TEST INPUT TO OUTPUT AND INPUT TO CASE .....	9
10.3 AC ISOLATION TEST INPUT TO OUTPUT AND INPUT TO CASE .....	9
<b>11 TROUBLE SHOOTING .....</b>	<b>9</b>
11.1 THERE IS NO OUTPUT VOLTAGE .....	9
11.2 THE INPUT FUSE BLOWS WHEN THE INPUT IS CONNECTED.....	9
11.3 THE CONVERTER STARTS AND STOPS REPEATEDLY .....	10
11.4 THE CONVERTER STOPS AFTER SEVERAL HOURS .....	10
11.5 FAULT REPORT .....	10

## 1 Before installation

On the front panel label the following is displayed: Converter type, input voltage range, nominal output voltage, serial number, options, article number, isolation voltages and ambient temperature range. The converter type name consists of model name PU1000 or PU600 followed by input code and output voltage. Two examples:

- **"Type: PU1000 110/48" has input code "110" and nominal output voltage 48Vd.c.**
- **"Type: PU600B24" has input code "B" and nominal output voltage 24Vd.c.**

Input, output and case are galvanically separated from each other. You can thus choose how you want the system connected.

The input is protected against reverse polarity by a parallel diode at the input on models with input code 24, 48, 72, A, B and C. This diode, however, is only intended to blow an external input fuse. 110, 220, 440 and D input codes have an inrush current limit thyristor, which also works as a series diode.

The input shall be fused with an approved fuse with a slow blow characteristic and high breaking capacity. See table 1.

**PU1000 input fuses**

Input voltage code	Time delay fuse
24	63 A
48	35 A
72	25A
110	16 A
220	8 A
440	6A

**PU600 input fuses**

Input voltage code	Time delay fuse
A	80 A
B	50 A
C	20 A
D	10 A

**Table 1. Recommended input fuses.**

There are two reasons we do not include the fuse.

1. DC-networks should be fused at the distribution point to protect the cable.
2. Different applications require different types of fuses.

If the converter is mounted in an electric vehicle, an external series diode on the input is recommended. Please contact your Polyamp dealer.

If the converter supplies a DC-motor, we recommend an external parallel diode at the motor poles to protect against reverse voltages.

For the disconnection ability, an external disconnection device, which is able to disconnect both polarities, shall be incorporated with the input power supply cord. The disconnection device must be properly labelled and easy accessible.

## 2 Installation

The converter shall be mounted in an enclosure, which meets the demands of EN60950 regarding fire, voltage hazard and mechanical strength.

The converter is supplied with mounting brackets. With these you can mount the converter in any direction. The converter is convection cooled and in order to get sufficient cooling there shall be a minimum of 30 to 50 mm space at upper and lower parts of the converter. If this is not possible, we recommend the use of an external fan.

Note that the expected life of the converter is dependant on converter temperature. For every 10°C that the temperature is lowered the expected life is approximately doubled. It is therefore crucial to cater for good ventilation and if possible to reduce ambient temperature.

To meet the EMC specifications in the enclosed "declaration of conformity" use twisted-pairs for connecting input, output, alarm, inhibit and voltage sense. Shielded cables are not necessary.

1. Remove plastic cover.
2. Connect protective earth to the connection marked no 40. Use a ring terminal that has been crimped by an appropriate tool.
3. Connect the output. The converter output is short-circuit proof by a constant current limit which works unlimited in time. Therefore there is no need to fuse the load (unless you use multiple loads, see below). The current limit is fixed to 105% of nominal output current.
  - If the converter is to be connected in parallel at the output or if you use current sharing for equal current sharing, please consult 3 *Parallel connection* on page 5.
  - If you intend to use multiple loads, please consult 4 *Multiple loads at the output* on page 6.
  - If you intend to use the alarm, please consult 5 *Alarm* on page 7.
  - If you intend to use output voltage sense, please consult 6 *Sense* on page 7.
  - If you intend to use inhibit, please consult 7 *Inhibit* on page 8.

4. Connect the input cables. Bundle input cables together at the terminals separated from the output cables. Make the same arrangement on the output side. This is to make sure one cable will not bridge the insulation barrier in case of coming loose.

5. Start the converter with your external input disconnection device.

### Beware of hazardous voltages!

- The output voltage can be adjusted +10% to -5% of nominal output voltage with the potentiometer marked V.ADJ on the front panel. Clockwise turn increases the output voltage. The potentiometer has 15 turns. If you are using current sharing, the procedure of adjusting the output voltage is described in 3.3 *Voltage adjustment with current sharing* on page 6.
5. Replace plastic cover.
6. When the converter is disconnected, switch-off the input voltage with the disconnecting unit. Disconnect the input cables first, then output and last the protective case connection.

## 3 Parallel connection

If a redundant power supply system is requested, two or more converters can be connected in parallel. To achieve redundancy the number of converters must be dimensioned to carry the whole load even if one converter is faulty. Connect your load to the + output after the series diode, see *Figure 1*.

Another reason for connecting two or more converters in parallel is to get more power. Use the output with series diode, see *Figure 1*.

You should **not use external sense** when the unit are in parallel on the output.

### 3.1 Series diode on the output

The series diode protects the converter output from external voltage sources. A series diode is necessary if the output is connected in parallel with another power supply or if you require redundant operation. If a converter breaks down with an internal short-circuit on the output and other converters are connected in parallel on the output, the broken unit will short-circuit the others if the

series diode is not used. This might cause excessive heat or even fire in the faulty unit.

If the series diode is used, the alarm relay will switch to "ALARM" on the faulty unit if one converter breaks down in a redundant power supply system. Otherwise there will be no alarm indication from a faulty converter unless all units are in current limit and the output voltage drops 10% below nominal output voltage.

When the series diode is used the total output power of the converter must be **derated**. See data sheet.

- On 24Vd.c. output by 10%.
- On 48Vd.c. output by 5%.

Do not forget to fuse the inputs separately to achieve redundancy.

### 3.2 Current sharing

All models include the automatic current sharing feature, which we recommend to use in parallel configuration. A maximum of 10 (10) units can be connected in parallel.

If more than 10 units should be connected in parallel, contact Polyamp.

Connect a cable (0.25-1.0mm<sup>2</sup>) with a maximum length of 3.0m between the "CURRENT SHARE" connectors of all units.

The converter with the highest output voltage will then automatically become "current master". This converter will then run with a few percent higher output current than the others. If the master converter for some reason breaks down, another converter automatically becomes "current master".

To achieve good power sharing, the voltage drop between the minus poles must be kept as low as possible, see *Figure 1*. The plus poles can either be connected as in *Figure 1* or have separate cables to the load.

At light load (if the total load is less than 5% of the total rated power) the yellow "C. MASTER" LED might flicker between the units. As the load changes different units "C. MASTER" LED might be lit. All this is normal.

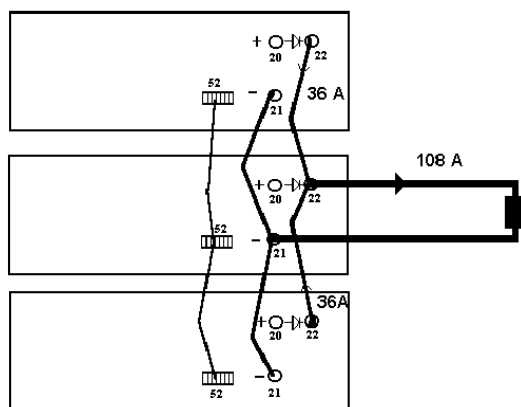

**Figure 1. Current share connection with series diode.**

### 3.3 Voltage adjustment with current sharing

The converters must be running with 5% of nom. load or more, and the "current share" must be connected. If each converter output voltage is adjusted to the same voltage, which they are at delivery, the yellow "C. MASTER" LED might be lit on most units.

To **increase** the output voltage:

1. Choose a unit where the "C. MASTER" LED is lit. Turn the V.ADJ potentiometer clockwise until you reach your desired output voltage.
2. The other units should now also be adjusted to approximately the same output voltage, otherwise the output voltage will drop if the master converter breaks down. Turn the V.ADJ potentiometer slowly clockwise on the other units until the "C. MASTER" LED is lit or almost lit.

To **decrease** the output voltage:

1. Turn the V.ADJ potentiometer approximately one (1) turn counter clockwise on all converters but one. This will not affect the output voltage yet.
2. Turn the V.ADJ potentiometer counter clockwise on the remaining converter (if your load current exceeds 5% of the total rated current, this should be the only unit with the "C. MASTER" LED lit) until you reach the output voltage you desire. (If you turn more than one (1) turn counter clockwise you must repeat from step 1).
3. The other units should now also be adjusted to approximately the same output voltage. Otherwise the output voltage will drop if the

master converter breaks down. Turn clockwise on the V.ADJ potentiometer on the other units slowly until the "C. MASTER" LED is lit or almost lit.

## 4 Multiple loads at the output

If you are using several loads, we recommend fusing them separately with fast acting fuses on the positive output branch. Some considerations regarding short-circuits should be taken. See below.

### 4.1 Short-circuits

1. If there is a short-circuit in one branch and the total current in all branches **does not** exceed 105% of the nominal current of the converter (see label on front panel), the output voltage will not be affected. The time for the fuse to blow can be calculated from the data sheet of the fuse if you know the short-circuit current through the fuse.
2. If there is a short-circuit in one branch and the total current in all branches **does** exceed 105% of the nominal current of the converter, the output voltage will drop until the fuse is blown. Depending on the impedance of the short-circuit (whether it is abrupt or merely an overload) and the resistance of the load cables, the effects of a short-circuit will vary.

Long cables reduce short-circuit currents, resulting in longer delay until the fuse is blown and hence an increased voltage dip. Light overload does not necessarily result in a blown fuse.

To reduce the voltage drop at short-circuit and if any branch has more than approximately 30% of the total output current of the converter, a large external capacitor is recommended. Such a capacitor will supply the peak current needed to blow the fuse, see *Figure 2*. To calculate the capacitor needed, use the following formula:

$$C = 1.2 \times (I_s \times \Delta t) / \Delta U$$

1.2 = Safety margin.

$I_s$  = Short-circuit current through the fuse.

$\Delta t$  = Time before the fuse blows (see data sheet on the fuse).

$\Delta U$  = Acceptable voltage dip before the fuse blows.

Example:

You have a 5A fuse with fast characteristic and the short-circuit current is 50A. The data sheet

gives you that  $\Delta t = 10\text{ms}$ . The output voltage is 24V, and you can accept 10% voltage drop =>  $\Delta U = 24 \times 0.1 = 2.4\text{V}$ .

The capacitance you need:

$$C = 1.2 \times (I_S \times \Delta t) / \Delta U = 1.2 \times 50 \times 0.01 / 2.4 = 250,000\mu\text{F}$$

Choose a capacitance with a rated voltage of at least 115% of nominal output voltage of the converter.

Repeat this calculation for all branches and choose the highest capacitance value.

- It is sometimes difficult to estimate the short-circuit current when the nature of a fault is unknown. In this case a voltage dip might appear under some short-circuit conditions even with a large capacitor present. If a voltage dip is critical in one branch it is recommended to use a separate DC/DC converter supplying this branch.

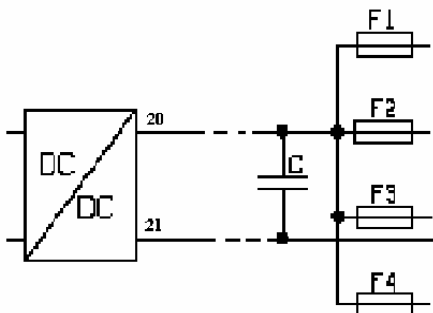

Figure 2. Connecting multiple loads.

## 5 Alarm

The alarm relay switches to "ALARM" state if:

- The output voltage is not within +15% /-10% of nominal output voltage.
- The converter is overheated.

Otherwise the relay contact is in the position "NORMAL".

The alarm relay can be connected in two ways:

- Normally Open (NO).
  - Connect twisted-pair (0.25mm<sup>2</sup> -1.5mm<sup>2</sup>) from centre pin of the removable alarm connector and connector pin marked "ALARM".

- Normally Closed (NC).
  - Connect twisted-pair (0.25mm<sup>2</sup> -1.5mm<sup>2</sup>) from centre pin of the removable alarm connector and connector pin marked "NORMAL".

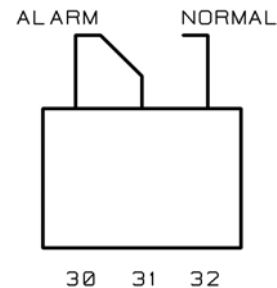

Figure 3. Alarm contact.

The relay is isolated 2500V a.c. from input, output and case. The relay can switch maximum 30V/5A (a.c. and d.c. values).

### 5.1 Over and under voltage alarm

The alarm relay switches to alarm and the "REG NOT OK" LED is lit when the output voltage is approximately 15% higher or 10% lower than nominal output voltage. When the output voltage is normal, the relay contact is in the position printed on the front panel.

### 5.2 Over temperature

All models have thermal protection. If the converter is overheated it reduces its maximum output power. The "OVER TEMP" LED is lit and the alarm relay is set to alarm. This will not occur in normal operation with an ambient temperature below +55°C when the unit has sufficient cooling. The converter is convection cooled and there should be a minimum of 30-50mm of free space at upper and lower parts of the converter. If this is not possible, we recommend the use of an external fan.

Note that the expected life of the converter is dependant on converter temperature. For every 10°C that the temperature is decreased the expected life is approximately doubled. It is therefore crucial to cater for good ventilation and if possible reduce ambient temperature.

## 6 Sense

### 6.1 External sense

External sense is used when voltage regulation at the load is critical. The converter regulates the voltage at the load and not at the output of the converter and does thereby compensate for voltage drop in the cables between the converter and the

load. The maximum voltage compensation is 5% of nominal output voltage.

Do not disconnect the negative power connection from the converter to the load before the positive, when the converter is running and external sense is used. This might damage the converter and it is also not advisable for Your own protection to make adjustments in the installation with voltage applied.

1. Remove the jumpers from the sense inputs at the removable connector.
2. Connect a twisted-pair (0.25mm<sup>2</sup> -1.5mm<sup>2</sup>) between the sense terminals of the converter and the load, see *Figure 4*. The sense leads and the power cables shall be of approximately the same length and drawn as close to each other as possible. **Beware of correct polarity!**

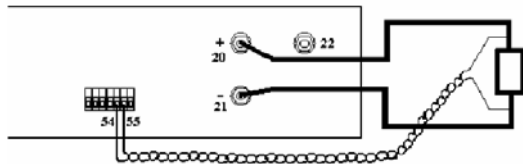

Figure 4. External sense.

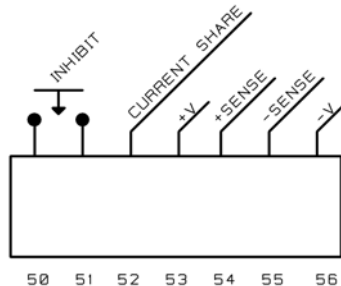

Figure 5. Feature contact.

### 6.2 Internal sense

If external sense is not used, the jumpers shall be connected between "+SENSE" and "+V" and between "-SENSE" and "-V", as they are at delivery. The converter then regulates the voltage at its output screw terminals.

### 7 Inhibit

The converter is shut-down if the inhibit input is short-circuited by a relay or an electrical switch. The current through the short-circuit is 20mA. Note that there is no electrical isolation between the inhibit and the output.

1. Use a twisted-pair (0.25mm<sup>2</sup> -1.5mm<sup>2</sup>) with a maximum length of 3.0m for connection of the inhibit.

### 8 Output over voltage protection

All models are equipped with an internal output over voltage protection circuit (OVP). It consists of an additional voltage regulator operating in parallel with the main regulator. The output voltage is limited to approximately 15% above the nominal output voltage. As long as the OVP circuit is active the alarm relay is set to "ALARM" state and the red "REG NOT OK" LED is lit.

### 9 Inrush current limit

Models with input codes 110, 220, 440 and D are equipped with "inrush current limit" feature. The input capacitors are charged through a resistor to reduce the input current during start up. When the converter starts this resistor is shunted by a thyristor, which also acts as a series diode.

All models have a "slow start" feature. To reduce input current during start up the output capacitors are charged "slowly" (approximately 0.1s).

### 10 Isolation voltage test

Each converter has been isolation tested in factory before delivery see *Table 2*. **Warning! An isolation test shall only be performed by personnel aware of the dangers and hazards of the test.**

Input code	Isolation In/out, In/case	Output voltage Vd.c.	Isolation out/case
24, 48, 72, A, B	2.0kVd.c.	24, 48	2.0kVd.c.
110, 220, 440, C, D	2.5kVa.c.	24, 48	2.0kVd.c.

Table 2. Isolation voltages on different converters.

#### 10.1 DC isolation test output to case

1. Disconnect all cables from the converter.
2. Connect the input terminals of the converter to case.
3. Connect the output terminals together.
4. Connect your isolation tester between output and case. See *Figure 6*. Raise the voltage of the isolation tester from 0 to 2000Vd.c. Check that



the leakage current does not exceed  $5\mu\text{A}$ . The voltage should not be applied for more than a few seconds or the Y-capacitors might be damaged.

- Turn off the isolation tester and discharge the test voltage with a  $10\text{ M}\Omega$  resistor between output and case.



Figure 6. Output to case isolation voltage test.

### 10.2 DC isolation test input to output and input to case

- Disconnect all cables from the converter.
- Connect the output terminals of the converter to case.
- Connect the input terminals together.
- Connect your isolation tester between input and case. See Figure 7. Raise the voltage of the isolation tester from 0 to  $2000\text{Vd.c}$ . Check that the leakage current does not exceed  $5\mu\text{A}$ . The voltage should not be applied for more than a few seconds or the Y-capacitors might be damaged.
- Turn off the isolation tester and discharge the test voltage with a  $10\text{ M}\Omega$  resistor between input and case.

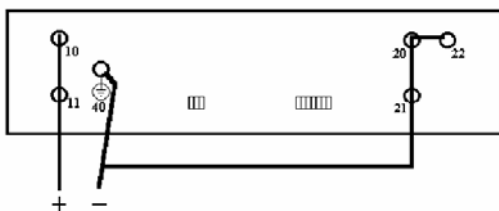

Figure 7. Input to output and input to case isolation voltage test.

### 10.3 AC isolation test input to output and input to case

You can also test  $2500\text{Va.c}$ . for one (1) minute between input to output and case on units with input codes 110, 220, 440, C and D.

**Beware of the rather high capacitive earth currents (about  $100\text{mA}$ ) that will occur during this test.**

If your isolation test equipment cannot supply this current, you can perform a DC isolation test with  $4000\text{Vd.c}$  ( $2500\text{V} \times \sqrt{2} \times 1.1 \approx 4000\text{Vd.c}$  where  $1.1 = \text{safety factor}$ ). Follow the instructions in 10.2. *DC isolation test input to output and input to case* above but test with  $4000\text{Vd.c}$ . instead of  $2000\text{Vd.c}$ . The leakage current should not exceed  $5\mu\text{A}$ .

AC isolation test:

- Disconnect all cables from the converter.
- Connect the output terminals of the converter to case. See Figure 7.
- Connect the input terminals together.
- Connect your isolation tester between input and case. See Figure 7. Raise the voltage of the isolation tester from 0 to  $2500\text{Va.c}$ . The voltage should not be applied for more than one (1) minute or the Y-capacitors might be damaged.
- Turn off the isolation tester and discharge the test voltage with a  $10\text{ M}\Omega$  resistor between input and case.

## 11 Trouble shooting

### 11.1 There is no output voltage

- Check that the input fuse is not broken.
- Check that the input voltage polarity is correct.
- Check that the input voltage is within the specified limits, see front label.
- If the red "REG NOT OK" LED is lit, the converter may be in current limit due to excessive output current or an external short-circuit on the output.

- Disconnect the input.
- Disconnect the load.
- Connect the input again and measure the output voltage.

If the converter now starts the load was too heavy or there was a short-circuit.

- If there is an external short-circuit, remove it.
  - If the load is too large decrease the load or consult your Polyamp dealer.
- Check that the "INHIBIT" input is not short-circuited. See 7 Inhibit on page 8.
  - Check that the "SENSE" is connected correctly. See 6 Sense on page 7.
  - The unit is broken. Contact your Polyamp dealer.

### 11.2 The input fuse blows when the input is connected

- Check that the input voltage polarity is correct.
- Check that the input fuse is of time delay type and with correct current rating. See Table 1.

---

Some models have "inrush current limit". For further information consult 9 *Inrush current limit* on page 8.

2. The unit is broken. Contact your Polyamp dealer.

### **11.3 The converter starts and stops repeatedly**

All models have an over/under voltage protection which shuts down the converter if the input voltage is not within specified limits (see front label).

1. The cables to the converter input may be undersized, causing too high voltage drop in the supply cables.
2. Your supply does not have enough current capacity so the input voltage to the converter drops below specified limit.

### **11.4 The converter stops after several hours**

If the red "OVER TEMP" LED is lit, the unit has not sufficient cooling or the ambient temperature is too high. See 5.2 *Over temperature* on page 7 for further information.

### **11.5 Fault report**

We suggest that you return a faulty converter to:

POLYAMP AB  
Box 229 / Bäckgatan 10  
S-597 25 ÅTVIDABERG  
SWEDEN

Tel: +46 120 85400

Fax: +46 120 85405

or to your local Polyamp distributor.

To help us locate the fault, please describe the fault and how and when it occurred.

Info: [https://www.dieselelectric.com/?id\\_product=1154](https://www.dieselelectric.com/?id_product=1154)

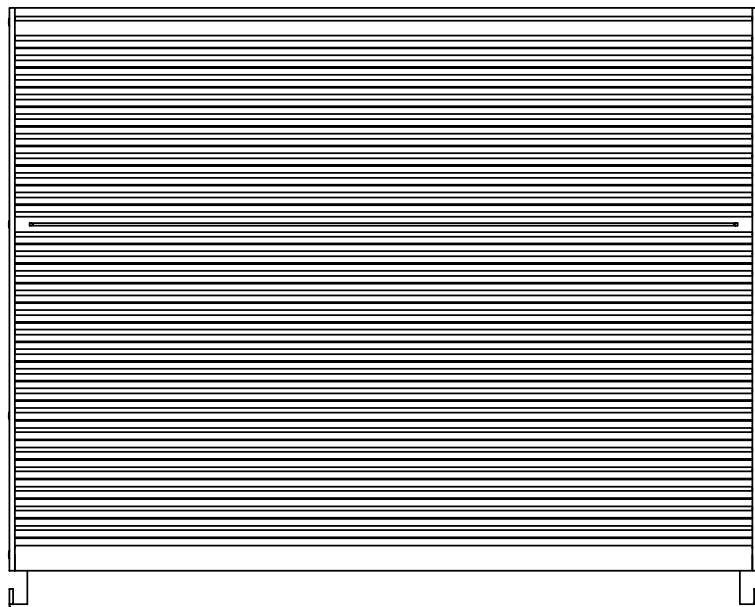
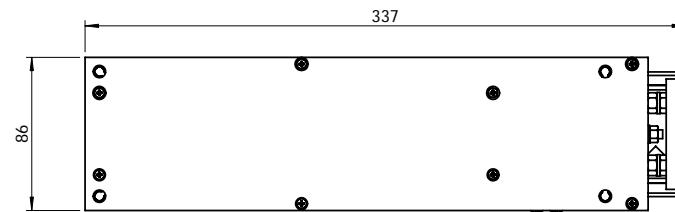
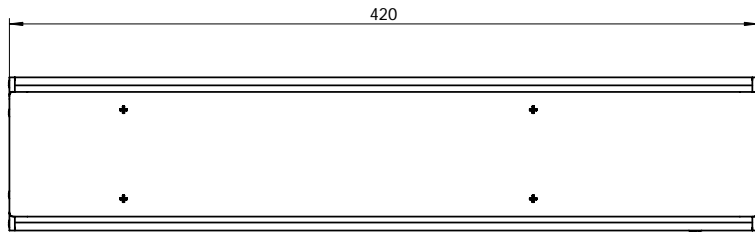

This document is the property of Polyamp AB and shall not, without the permission of Polyamp AB be allowed, copied, used for manufacturing or communicated to any other person or company.

Weight (kg/ft <sup>3</sup> )	Replaces dwg	Page 1(1)	Associated dwg No	Units millimeters	Scale 1:3	Rev No 00
		PU600 / PU1000		Tolerances/Tolerances IS:ISO 2768:1 m		Designer roand Date (y/m/d) 041021
				RA 6,3		Approved by Rev by Date (y/m/d)
				Dwg No.		PU1000

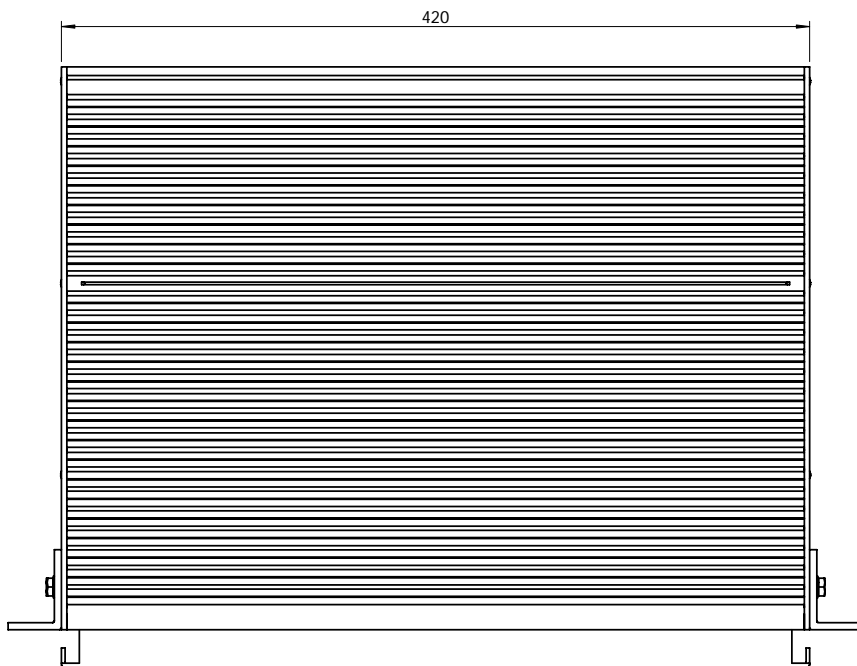
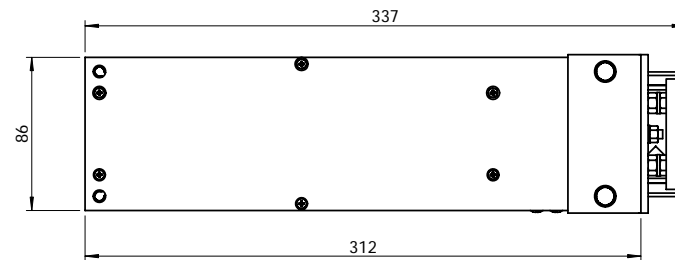
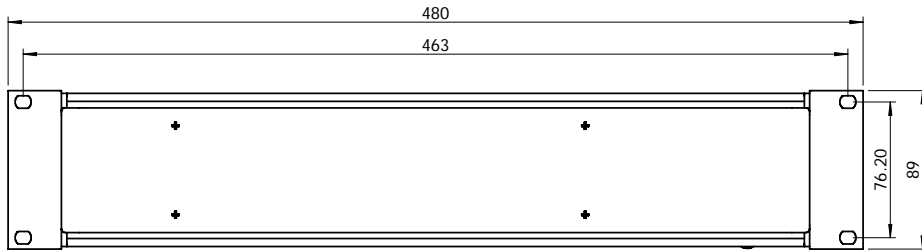

Rear mounting

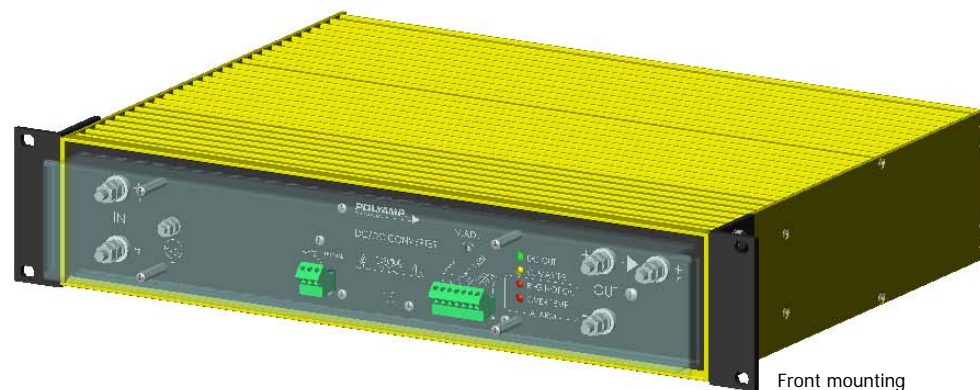

Front mounting

This document is the property of Polyamp AB and shall not, without the permission of Polyamp AB, be allowed, copied, used for manufacturing or communicated to any other person or company.

Weight (kg/m <sup>3</sup> )	Replaces dwg	Page 1(1)	Associated dwg No	Units millimeters	Scale 1:3	Rev No 00
		PU600 / PU1000 L89-1 Standard mounting		Tolerances/Tolerances IS:ISO 2768-1 m Njammhet/Surf. text RA 6,3		Designer roand Date (y/m/d) 041021 Approved by Date (y/m/d) Rev by Date (y/m/d)
					Dwg No. 4820-00	

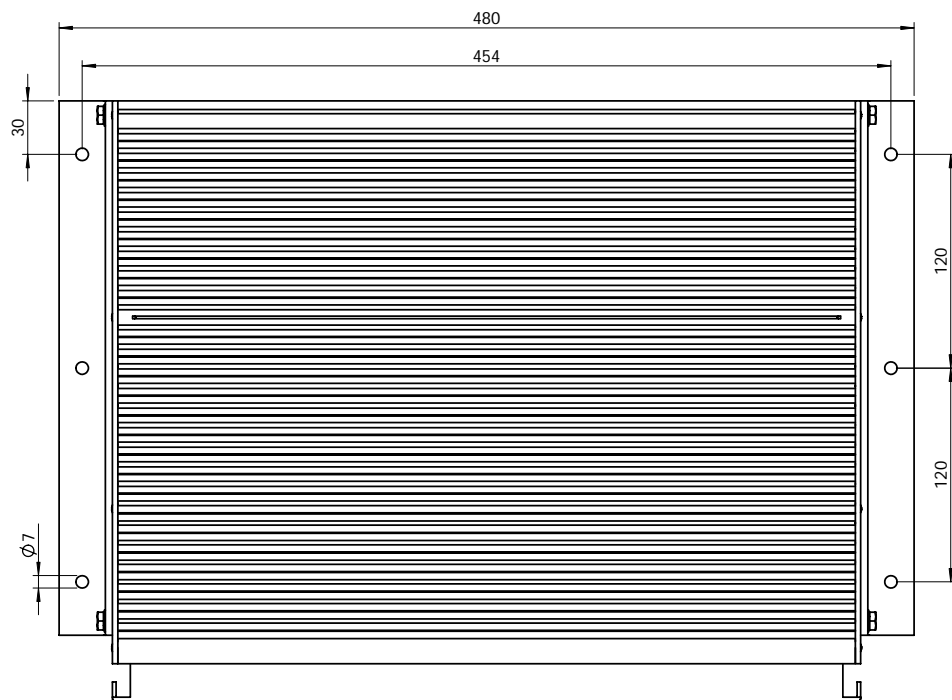
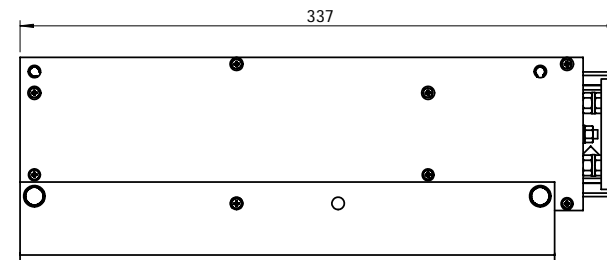
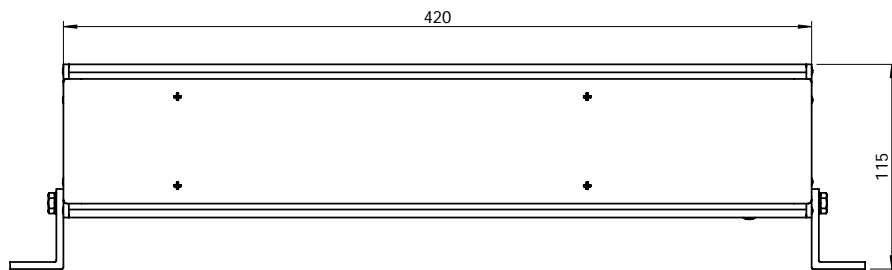

This document is the property of Polyamp AB and shall not, without the permission of Polyamp AB, be allowed, copied, used for manufacturing or communicated to any other person or company.

Weight (kg/m <sup>3</sup> )	Replaces (dwg)	Page 1(1)	Associated (dwg) No.	Units millimeters	Scale 1:3	Rev No. 00	
	PU600 / PU1000 400090 L300-1 Wall mounting		Tolerances/Tolerances IS:ISO 2768-1 m Njammhet/Surf. text RA 6,3		Designer roand Approved by Rev by	Date (y/m/d) 041021 Date (y/m/d) - Date (y/m/d) -	
	Dwg No.					4821-00	

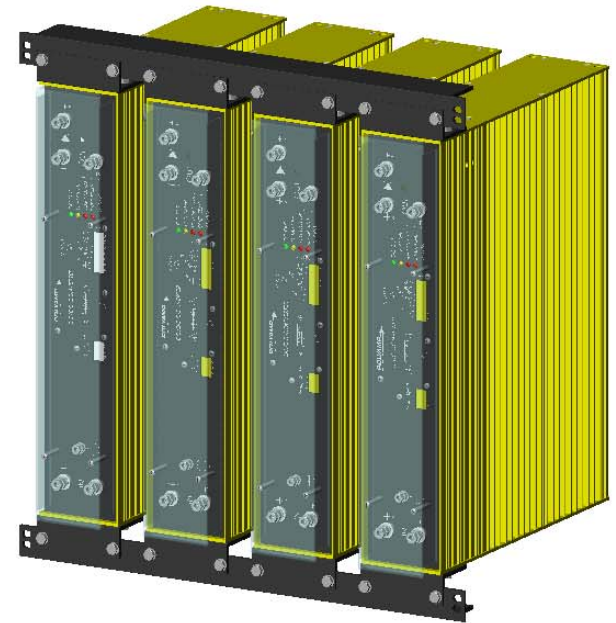
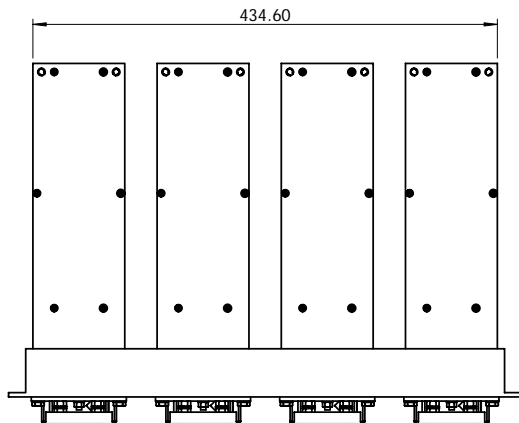
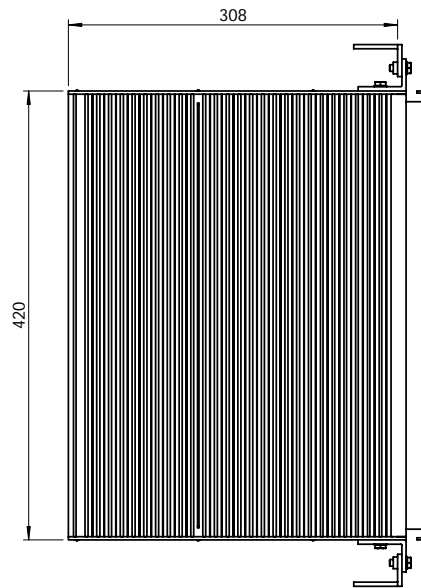
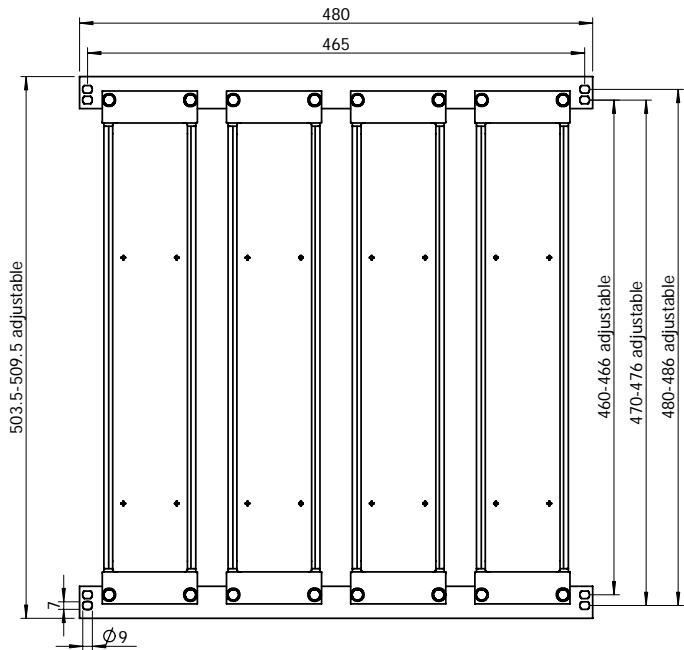

This document is the property of Polyamp AB and shall not, without the permission of Polyamp AB, be allowed, copied, used for manufacturing or communicated to any other person or company.

Weight (kg/m <sup>3</sup> )	Replaces dwg	Page 1(1)	Associated dwg No.	Units millimeters	Scale 1:5	Rev No. 00
	PU600 / PU1000 400091 L480-2 / L89-1 19" 4 units		Tolerances/Tolerances IS:ISO 2768-1 m	Designer roand Date (y/m/d) 041021	Approved by Date (y/m/d) -	Rev by Date (y/m/d) -
			Njammhet/Surf. text RA 6,3	Date (y/m/d) -	Date (y/m/d) -	Date (y/m/d) -
			Dwg No.	4822-00		