

Side View - Component Heights

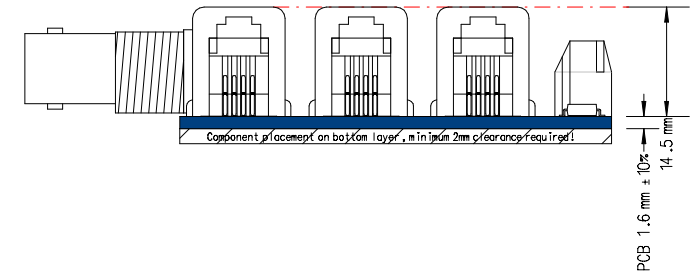

Birds Eye View - Component positioning along PCB edge Component Outlines & PCB Exported directly from PCB program

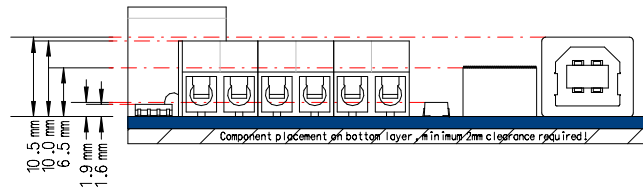
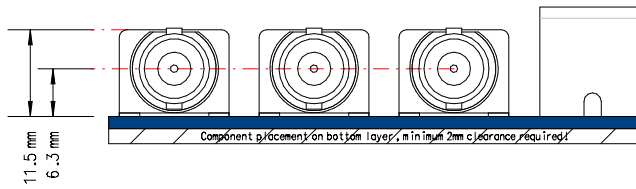
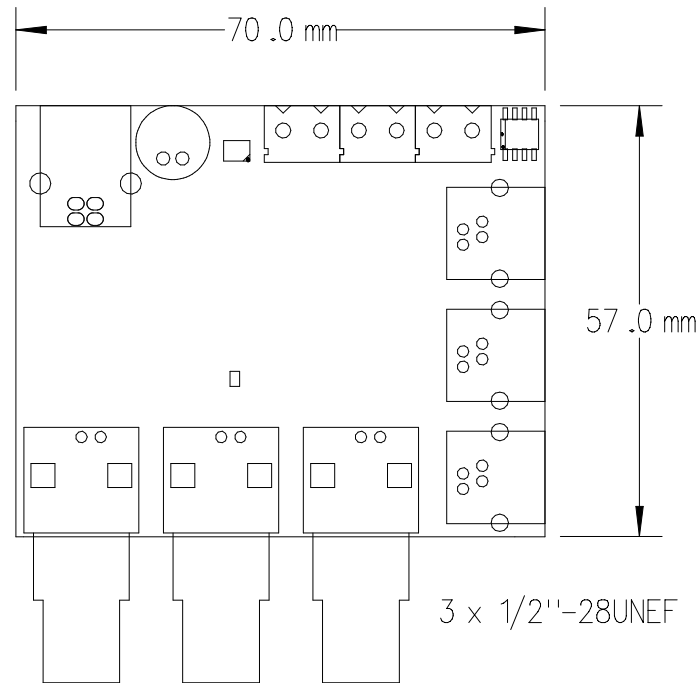
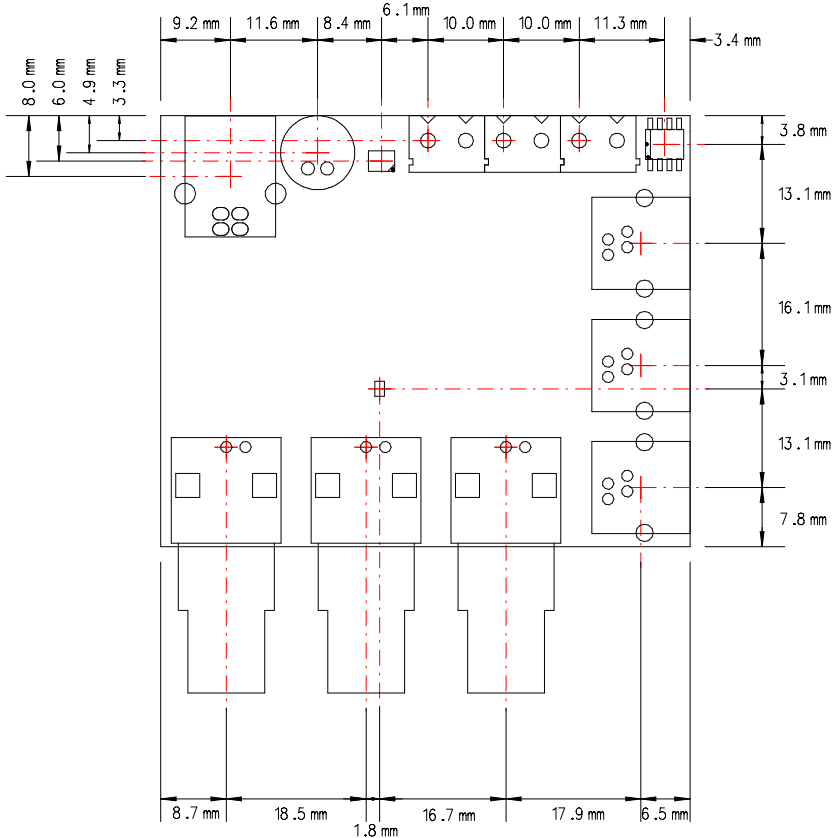

Types of connector

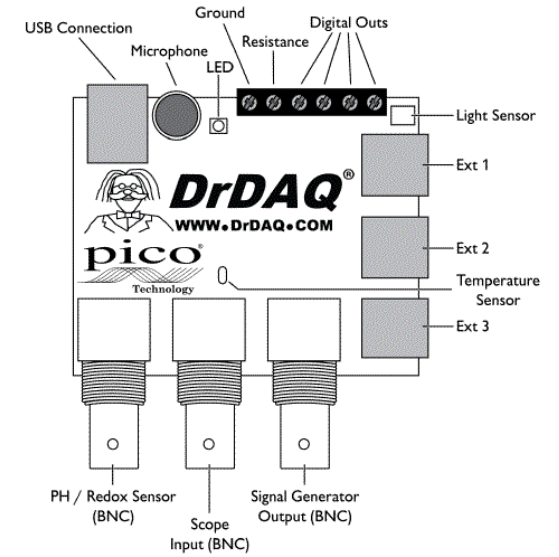

All dimensions are typical values and may vary.

Title: DrDAQ Dimensions Drawing

Drwg No. D0188-3

Copyright © 2011 Pico Technology Ltd.

Created: GB Date: 24FEB2011

Checked: PW Date: 04MAR2011

Dimensions Are In Millimetres
Drawing scale 1:1 at A4

pico
Technology
Tel: 01480 396395 Fax: 01480 396296